

Corbin
Russwin

ASSA ABLOY

ED5000 Series

Pushpad Exit Devices



ASSA ABLOY, the global leader
in door opening solutions

Overview

ED5000

Table of Contents

Overview	2
Product Series Features	3
Applications and Listings.....	4
SecureBolt® Features.....	6
Rim Features	8
Surface Vertical	
Rod Features.....	10
Concealed Vertical	
Rod Features	14
Rim/SecureBolt/SVR & CVR	
Functions.....	18
Trims and Functions.....	20
Mortise Features	26
Mortise Functions	28
Mortise Trims and	
Functions.....	30
Electrified Exit Devices.....	36
Mullions and	
Surface Bolt Kit.....	48
Options and Accessories ...	49
Facts and Figures	52
Cylinders.....	53
Quick Codes	55
How to Order	58
Helpful Terms	61
How to Specify	62

Applications

Corbin Russwin's history is rich with architectural hardware designed to meet life safety and security requirements. That tradition continues with ED5000 Series exit devices. Designed to allow safe and easy egress, the ED5000 is ideal for frequent use applications such as schools, factories, hotels, theaters, office, retail complexes and government buildings.

Quality

All exit devices manufactured by Corbin Russwin undergo rigorous testing, both in the lab and field. Testing procedures go beyond industry standards; the ED5800 concealed vertical rod exit device was witnessed and certified to 3.25 million successful cycles, more than 6 times the requirement. Abuse and cycle tests prove time and again the durability of the entire ED5000 series, which is backed by a 5-year warranty.

Aesthetics

Over the past 100 years, Corbin Russwin has been well-known for weaving pleasing aesthetics and inventive designs into architectural door hardware, and today's wide stile exit device line is no exception. The ED5000 Series offers smooth lines in the exit device bar and a full range of trim designs with visual diversity, including the Muséo® and Vineyard™ Collections.

Vandal Resistance

Today's door hardware must fulfill life-safety and security needs, two areas in which ED5000 series exit devices and trim excel. The ED5200S SecureBolt® features a deadbolt style latchbolt that significantly resists pull from the exterior, thus reducing door and frame separation, preventing the door from being forced open. 900 series heavy-duty trim deters vandals with a thick 13/16" beveled escutcheon, Free Wheeling lever (excluding mortise trim), and flush cylinder. High security Pyramid cylinders offer an additional barrier against picking and drilling. These components can all be combined for high quality, high security applications.

Electronics

If electronic access control is required, or just a simple monitoring switch, the ED5000 series offers a full range of electrified options, including a delayed egress exit device and electrically controlled trim. All options can be tied into existing security and fire alarm systems for easy monitoring.

Product Series Features

ED5000

As Corbin Russwin continues to offer the latest technology and architectural hardware, an additional option is also presented to architects, distributors, and end-users. The power of choice. With a wide variety of devices, trims, lever designs, and electrified hardware, a locking system can be designed for any building and any application. Below are some highlights of the ED5000 Series. These are but a few of the options that can be combined to meet the aesthetic and security requirements of today.



SecureBolt® Delayed Egress Exit Device

SECUREBOLT®

SecureBolt®

- Deadbolt-style latch design provides increased security by resisting unauthorized entrance from credit cards, crowbars, door rattling, etc.
- Is more resistant to vector forces, which results in less force against the frame, thus eliminating door/frame separation
- Provides increased stability of openings with mullions

Delayed Egress Exit Device

- Increases security in many applications such as retail stores and health care facilities
- Features an LED indicator and a nuisance delay
- 15 or 30-second delay available
- UL and BHMA listed



PATHLITE™

Photoluminescent Touchpad Cover

The PathLite™ patent pending technology offers a number of benefits:

- Requires no wiring or maintenance
- Recharges with exposure to ambient light
- Unaffected by heat or cold
- Non-toxic, will not rub or fade
- Vandal resistant

- Fire resistant and non-radioactive
- Green contrasting word "EXIT" centered on touchbar in 1-1/4" high lettering
- Cost effective; especially suited for existing buildings

PathLite™ photoluminescent exit devices meet New York City's newly adopted standards for requirement of photoluminescent signage and stairwell markings in all office buildings in excess of 75 feet in height.



Heavy-Duty Trim with Vineyard lever

Vineyard™ collection

Heavy-Duty Trim

- Free Wheeling levers for vandal resistance (excluding mortise trim)
- Heavy-duty threaded posts provide additional strength
- Beveled sides for increased attack resistance
- Flush cylinder when used with 6-pin applications and mortise trim functions



Heavy-Duty Trim with Muséo® lever

MUSÉO®

Muséo® and Vineyard™ Collections

- Available in 605, 606, 611, 612, 613, 618, 619, 625, 626, 722 finishes
- Allows for design continuum when matched with the ML2000 series mortise lock Muséo and Vineyard Collection trims
- Heavy-duty vandal-resistant escutcheon increases security







Parabolic Trim with Vineyard™ lever Specify M60

Parabolic Trim with Vineyard™ Lever

- Specify M60

Applications and Listings

ED5000

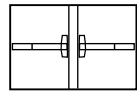
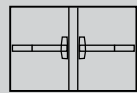
Single Door	UL Listing	Maximum Opening (W x H)	Application	
Rim				
ED5200	Panic	4' x *	Surface applied; single-point latching.	
ED5200A	3 Hr.	4' x 8'		
SecureBolt®				
ED5200S	Panic	4' x *	Surface applied; single-point latching.	
ED5200SA	3 Hr.	4' x 8'		
ED5200S x M107	Panic	4' x 8'	Surface applied; single-point latching. Used as components in swinging door windstorm-rated assemblies (refer to local codes).	
ED5200SA x M107	3 Hr.	4' x 8'		
Mortise				
ED5600	Panic	4' x *	Mortised in door; single-point latching.	
ED5600A	1-1/2 Hr.	4' x 9'		
ED5600A	3 Hr.	4' x 8'		
Surface Vertical Rod				
ED5400	Panic	4' x 8'	Surface applied; two-point latching.	
ED5470	Panic	4' x 10'		
ED5470 x M55	Panic	4' x 10'	Surface applied; one-point latching.	
ED5470 x M107	Panic	4' x 8'	Surface applied; two-point latching. Used as components in swinging door windstorm-rated assemblies (refer to local codes).	
Concealed Vertical Rod				
ED5800	Panic	4' x 8'	Rods concealed in door; two-point latching.	
ED5860	Panic	4' x 10'		
ED5860 x M55	Panic	4' x 10'	Rod concealed in door; one point latching.	
Pair of Doors with Removable Mullion				
Rim x Rim				
ED5200 x ED5200 x 900 Series	Panic	8' x 10'	Two independent active doors with removable mullion.	
ED5200A x ED5200A x 900 Series	3 Hr.	8' x 8'		
SecureBolt® x SecureBolt®				
ED5200S x ED 5200S x 900 Series	Panic	8' x 10'	Two independent active doors with removable mullion.	
ED5200SA x ED5200SA x 900 Series	3 Hr.	8' x 8'		
ED5200S x ED5200S x M107	Panic	8' x 8'	Two independent active doors with removable mullion. Used as components in swinging door windstorm-rated assemblies (refer to local codes).	
ED5200SA x ED5200SA x M107	3 Hr.	8' x 8'		

*UL does not set a door height limitation on panic applications.

Applications and Listings

ED5000

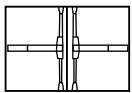
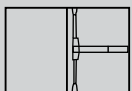
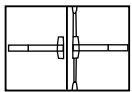
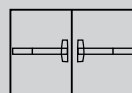
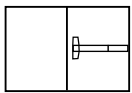
Pairs of Doors	UL Listing	Maximum Opening (W x H)	Application	
Surface Vertical Rod				
ED5400 x ED5400	Panic	8' x 8'	Two independent doors with two-point latching, swinging in the same direction.	
ED5400A x ED5400A	3 Hr.	8' x 8'		
ED5470 x ED5470	Panic	8' x 10'	Two independent doors with one or two-point latching, swinging in the same direction.	
ED5470B x ED5470B	1-1/2 Hr.	8' x 10'		
ED5470 x ED5470 x M107	Panic	8' x 8'	Two independent doors with two-point latching, swinging in opposite directions. Used as components in swinging door windstorm-rated assemblies (refer to local codes).	
ED5470B x ED5470B x M107	1-1/2 Hr.	8' x 8'		
Surface Vertical Rod (Double Egress)				
ED5400 x ED5400	Panic	8' x 8'	Two independent doors with two-point latching, swinging in opposite directions. Overlapping astragal required for 3-hour openings.	
ED5400A x ED5400A	3 Hr.	8' x 8'		
ED5470 x ED5470	Panic	8' x 10'	Two independent doors with one or two-point latching, swinging in opposite directions. Overlapping astragal not required.	
ED5470B x ED5470B	1-1/2 Hr.	8' x 10'		
Surface Vertical Rod x Mortise				
ED5400 x ED5600	Panic	8' x 8'	Overlapping astragal required for 3-hour openings. Coordinator required with standard ANSI strike.	
ED5400A x ED5600A	3 Hr.	8' x 8'		
ED5400A x ED5600A x Open Back Strike	1-1/2 Hr.	8' x 8'		
ED5470 x ED5600	Panic	8' x 10'	Overlapping astragal required for fire-rated openings. Coordinator required with standard ANSI strike.	
ED5470B x ED5600A	1-1/2 Hr.	8' x 9'		
Concealed Vertical Rod				
ED5800 x ED5600	Panic	8' x 8'	Two independent metal doors with two-point latching, swinging in the same direction.	
ED5800 x ED5800	Panic	8' x 8'		
ED5800A x ED5600A	3 Hr.	8' x 8'		
ED5800A x ED5800A	3 Hr.	8' x 8'		
ED5800A x ED5600A x Open Back Strike	1-1/2 Hr.	8' x 8'	Two independent metal or wood doors with one or two-point latching, swinging in the same direction.	
ED5860 x ED5600	Panic	8' x 10'		
ED5860 x ED5860	Panic	8' x 10'		
ED5860B x ED5600A	1-1/2 Hr.	8' x 10'		
ED5860B x ED5860B	1-1/2 Hr.	8' x 10'		
Concealed Vertical Rod (Double Egress)				
ED5800 x ED5800	Panic	8' x 8'	Two independent metal doors with two-point latching, swinging in opposite directions. Overlapping astragal required for 3-hour openings.	
ED5800A x ED5800A	3 Hr.	8' x 8'		
ED5860 x ED5860	Panic	8' x 10'	Two independent metal or wood doors with one or two-point latching, swinging in opposite directions. Overlapping astragal not required.	
ED5860B x ED5860B	1-1/2 Hr.	8' x 10'		

*UL does not set a door height limitation on panic applications.

SecureBolt® Features

ED5000

- ED5200S** **Panic-Listed SecureBolt® Exit Device**
- ED5200SA** **3-Hour Fire-Listed SecureBolt® Exit Device**
- ED5202S** **Panic-Listed Listed SecureBolt® Double Cylinder Exit Device**
- ED5202SA** **3-Hour Fire-Listed SecureBolt® Double Cylinder Exit Device**

SECUREBOLT®



Features

Handing

Standard device is non-handed.
Double Cylinder Device is handed.
Lever trim is handed.

Bar Length

Easily field cut to size.
Standard: 36" (914mm) bar fits 30" - 36" (762mm-914mm) door.
Optional: 24" (610mm) bar fits 24" (610mm) door; specify W024.
Optional: 48" (1219mm) bar fits 36" -48" (914mm-1219mm) door; specify W048.

Door Thickness

1-3/4" (44mm) standard.
Optional: 2" (51mm); specify D200.
Optional: 2-1/4" (57mm); specify D214.

Stile

Minimum width 4-1/2" (114mm).

Latchbolt

Full 3/4" (19mm) projection, 1" (25mm) wide, positive deadlocking by auxiliary bolt.

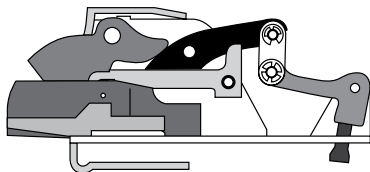

Cut Away Side View

Materials

Latchbolt: Nickel steel. Slide-action deadbolt with positive deadlocking by auxiliary bolt. Two-piece deadbolt mechanism utilizing a roll back lever which eliminates any contact (friction) with the strike during relocking.

Device: Heavy duty cold forged steel chassis; heavy gauge steel mechanisms, electroplated for corrosion resistance; finished parts are brass, bronze or stainless steel; stainless steel springs; nylon bearings.

Projection

3-1/4" (83mm) active, 2-3/4" (70mm) dogged.

Dogging

Standard on panic-rated devices; single-point 1/4 turn hex key dogging.

Optional: less dogging, specify M51.

Optional: cylinder dogging; specify M52.

Optional: electric dogging; specify M97.

Mechanical dogging not available on fire-rated devices.

Fasteners

Standard on panic devices: machine screws and wood door fasteners.

Standard on fire-rated devices: sex nuts and bolts.

Optional on devices: sex nuts and bolts for use on wood, composite or unreinforced metal doors; specify M54.

Optional wood screws for use on approved fire-rated solid wood or wood core doors. Specify M64.

Strike

Surface mounted 3/8" (10mm) diameter roller strike, complete with positive locking plate and shims, assuring low friction relocking for a long, trouble-free life.

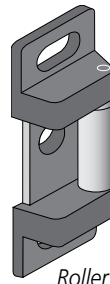

Roller Strike

Functions and Trims

Through-bolted lever, knob, pull and thumbpiece trims available with wide range of functions; see Trims and Functions, pages 20-25.

Cylinders

Cylinder not included unless specified. See Quick Codes, page 53.

Removable Mullion

See Mullions, page 48.

Shim Kit

Optional for mounting device over raised vision light molding; specify M58.

Applications and Listings

See page 4.

Warranty

Five-year limited.

Certification/Compliance

ANSI

Meets A156.3, Type 28, Grade 1.
Meets A117.1 Accessibility Code.

UL/cUL

All devices listed for safety as panic hardware; devices comply with UL 305 standards for panic hardware. Three-hour fire-rated devices listed as fire exit hardware for A label and lesser class 4' x 8' single or 8' x 8' double doors; UL symbol on active case cover indicates listing.

Any retrofit or other field modification to a fire-rated opening can potentially impact the fire rating of the opening, and Corbin Russwin, Inc. makes no representations or warranties concerning what such impact may be in any specific situation. When retrofitting any portion of an existing fire-rated opening, or specifying and installing a new fire-rated opening, please consult with a code specialist or local code official (Authority Having Jurisdiction) to ensure compliance with all applicable codes and ratings.

California State Reference Code

This product has been approved by the California State Fire Marshal pursuant to section 13144.1 of the California Health and Safety Code.

NFPA

All exit devices comply with NFPA 101 Life Safety Code. All fire-rated devices comply with NFPA 80 Fire Doors and Windows.

ADA

Exit devices, lever trims and pulls comply with Americans with Disabilities Act.

Finishes

BHMA 605	Bright Brass
BHMA 606	Satin Brass
BHMA 611	Bright Bronze
BHMA 612	Satin Bronze
BHMA 613	Oxidized Bronze, oil rubbed, available lacquered
613E	Dark Oxidized Satin Bronze Equivalent
BHMA 618	Bright Nickel Plated
BHMA 619	Satin Nickel Plated
BHMA 625	Bright Chromium Plated
BHMA 626* (Trim only)	Satin Chromium Plated
626C	Satin Chromium Plated with MicroShield®
BHMA 629	Bright Stainless Steel
BHMA 630	Satin Stainless Steel
630C	Satin Stainless Steel with MicroShield®
BHMA 722	Black oxidized bronze, oil rubbed

***Contact factory for devices required in BHMA 626**

SecureBolt® Features

ED5000

ED5200S and ED5200SA SecureBolt® Exit Devices

SECUREBOLT®

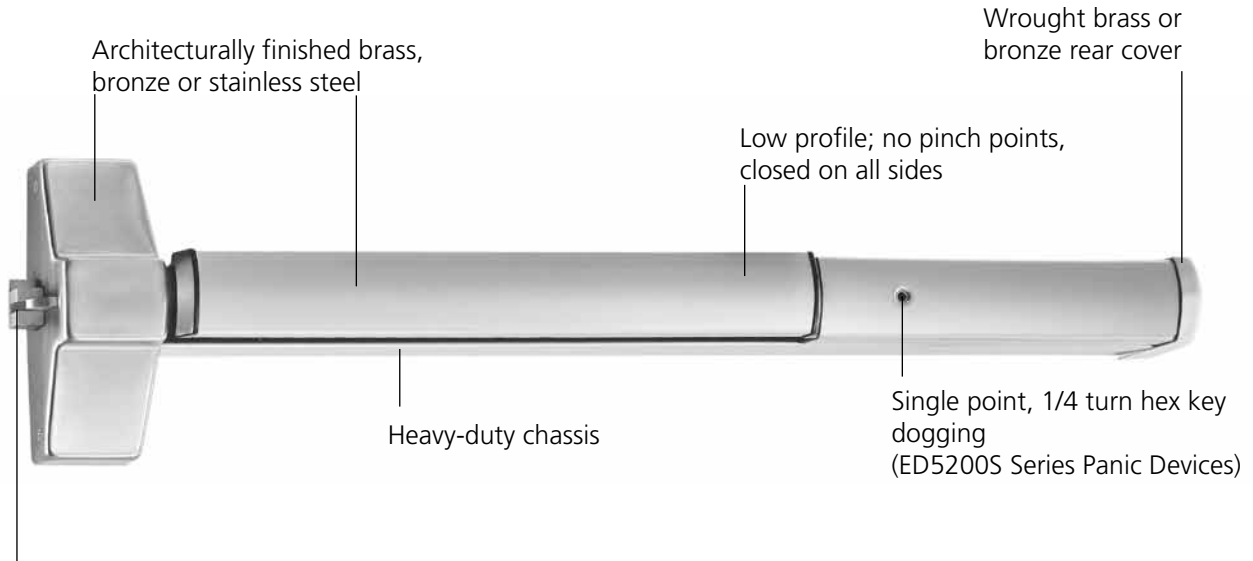

3/4" (19mm) projection x 1" wide deadbolt- style latchbolt with positive deadlocking by auxiliary bolt



In terms of an exit device, vector forces mean that pressure applied to the door results in a force against the stop and the frame, resulting in door/frame separation. The standard pullman latchbolt applies 280 pounds of force against the frame from a 400- pound pull on the door.

The SecureBolt® exit device only applies 63 pounds of force against the frame from a 400-pound pull on the door. Less force means the door and frame do not separate, providing a higher level of security, as the door cannot be pulled open.

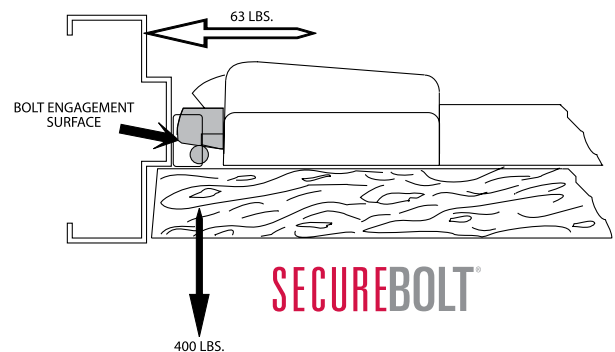
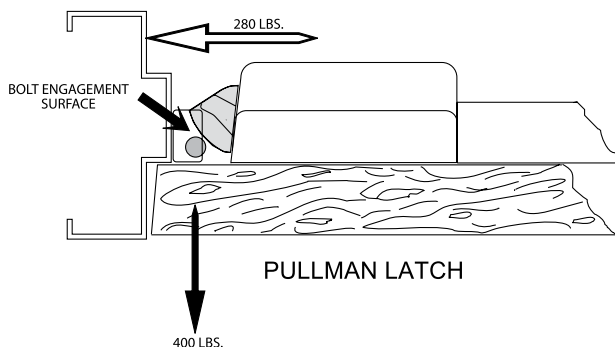

Rim Features

ED5000

- ED5200** **Panic-Listed Rim Exit Device**
- ED5200A** **3-Hour Fire-Listed Rim Exit Device**
- ED5202** **Panic-Listed Listed Rim Double Cylinder Exit Device**
- ED5202A** **3-Hour Fire-Listed Rim Double Cylinder Exit Device**



Features

Handing

Standard device is non-handed.
Double Cylinder Device is Handed.
Lever trim is handed.

Bar Length

Easily field cut to size.
Standard: 36" (914mm) bar fits 30" - 36"
(762mm-914mm) door.
Optional: 24" (610mm) bar fits 24" (610mm)
door; specify W024.
Optional: 48" (1219mm) bar fits 36" -48"
(914mm-1219mm) door; specify W048.

Door Thickness

1-3/4" (44mm) standard.
Optional: 2" (51mm); specify D200.
Optional: 2-1/4" (57mm); specify D214.

Stile

Minimum width 4-1/2" (114mm).

Latchbolt

3/4" (19mm) throw, stainless steel pullman-
type with stainless steel deadlocking latch.

Materials

Heavy-duty cold-forged steel chassis; heavy-
gauge steel mechanisms, electroplated
for corrosion resistance; finished parts are
brass, bronze or stainless steel; stainless steel
springs; nylon bearings.

Projection

3-1/4" (83mm) active, 2-3/4" (70mm) dogged.

Dogging

Standard on panic devices; single-point 1/4
turn hex key dogging.
Optional: less dogging, specify M51.
Optional: cylinder dogging; specify M52.
Optional: electric dogging; specify M97.
Mechanical dogging not available on fire-
rated devices.

Fasteners

Standard on panic devices: machine screws
and wood door fasteners. Standard on fire-
rated devices: sex nuts and bolts. Optional
on panic devices: sex nuts and bolts for use
on wood, composite, or unreinforced metal
doors; specify M54. Optional wood screws for
use on approved fire-rated solid wood or wood
core doors. Specify M64.

Strike

Surface-mounted 3/8" (10mm) diameter roller
strike, complete with positive locking plate and
shims, assuring low friction relocking for a long,
trouble-free life.

Functions and Trims

Through-bolted lever, knob, pull and
thumbpiece trims available with wide range
of functions; see Trims and Functions, pages
20-25.

Cylinders

Cylinder not included unless specified. See
Quick Codes, page 53.

Removable Mullion

See Mullions, page 48.

Shim Kit

Optional for mounting device over raised vision
light molding; specify M58.

Applications and Listings

See page 4.

Warranty

Five-year limited.

Certification/Compliance

ANSI

Meets A156.3, Type 1, Grade 1.
Meets A117.1 Accessibility Code.

UL/cUL

All devices listed for safety as panic hardware;
devices comply with UL 305 standards for panic
hardware. Three-hour fire-rated devices listed
as fire exit hardware for A label and lesser class
4' x 8' single or 8' x 8' double doors; UL symbol
on active case cover indicates listing.

Any retrofit or other field modification to a fire
rated opening can potentially impact the fire
rating of the opening, and Corbin Russwin,
Inc. makes no representations or warranties
concerning what such impact may be in any
specific situation. When retrofitting any portion
of an existing fire rated opening, or specifying
and installing a new fire-rated opening, please
consult with a code specialist or local code
official (Authority Having Jurisdiction) to ensure
compliance with all applicable codes and
ratings.

California State Reference Code

This product has been approved by the
California State Fire Marshal pursuant to
section 13144.1 of the California Health and
Safety Code.

NFPA

All exit devices comply with NFPA 101 Life
Safety Code. All fire-rated devices comply
with NFPA 80 Fire Doors and Windows.

ADA

Exit devices, lever trims and pulls comply
with Americans with Disabilities Act.

Finishes

BHMA 605	Bright Brass
BHMA 606	Satin Brass
BHMA 611	Bright Bronze
BHMA 612	Satin Bronze
BHMA 613	Oxidized Bronze, oil rubbed, available lacquered
613E	Dark Oxidized Satin Bronze Equivalent
BHMA 618	Bright Nickel Plated
BHMA 619	Satin Nickel Plated
BHMA 625	Bright Chromium Plated
BHMA 626* (Trim only)	Satin Chromium Plated
626C	Satin Chromium Plated with MicroShield®
BHMA 629	Bright Stainless Steel
BHMA 630	Satin Stainless Steel
630C	Satin Stainless Steel with MicroShield®
BHMA 722	Black oxidized bronze, oil rubbed

***Contact factory for devices required in
BHMA 626**

Rim Features

ED5000

ED5200 and ED5200A Rim Exit Devices

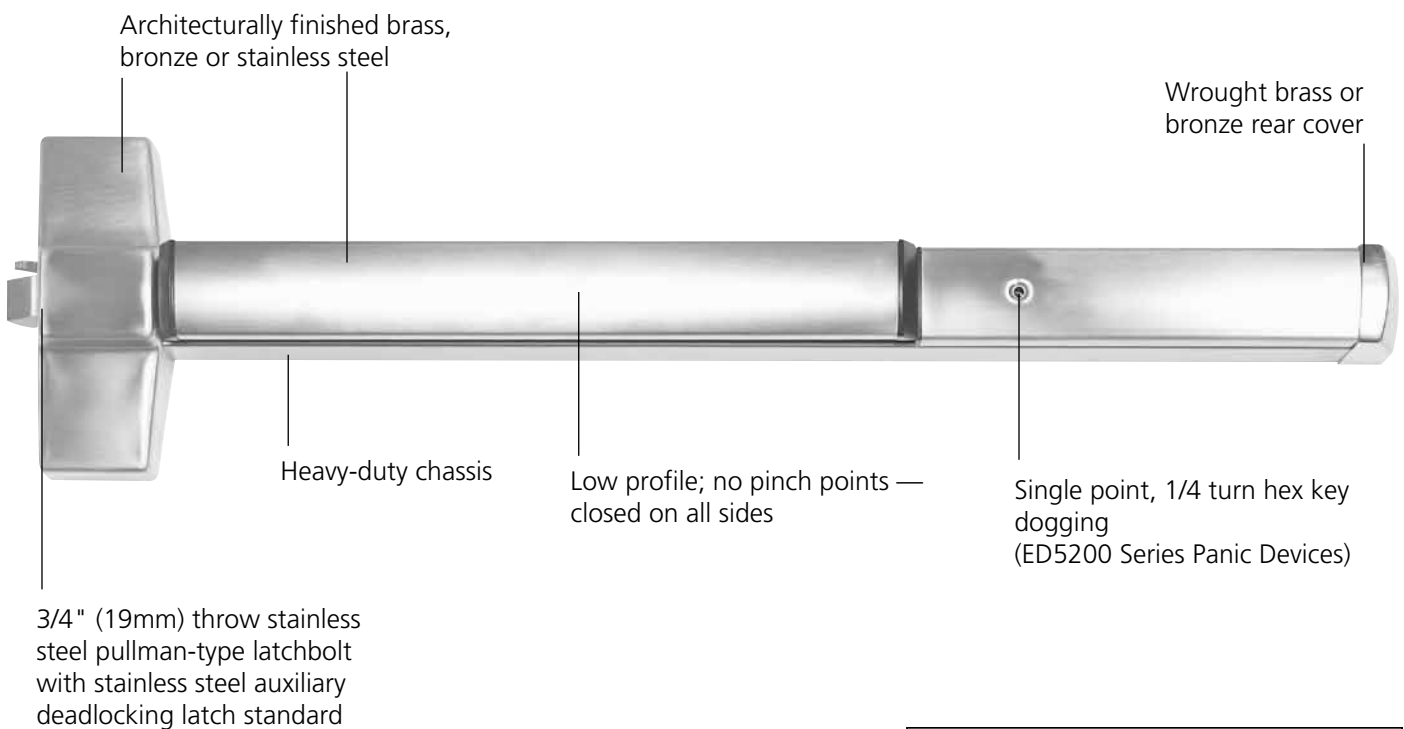

Surface Vertical Rod Features

ED5000

ED5400 Panic-Listed Surface Vertical Rod Exit Device ED5400A 3-Hour Fire-Listed Surface Vertical Rod Exit Device

Features

Handing

Device is handed but easily field reversible. Lever trim is handed.

Bar Length

Easily field cut to size.
Standard: 36" (914mm) bar fits 30" - 36" (762mm-914mm) door.
Optional: 24" (610mm) bar fits 24" (610mm) door; specify W024.
Optional: 48" (1219mm) bar fits 36"-48" (914mm-1219mm) door; specify W048.

Door Thickness

1-3/4" (44mm) standard.
Optional: 2" (51mm); specify D200.
Optional: 2-1/4" (57mm); specify D214.

Stile

Minimum width 4-1/2" (114mm).

Door Height

Standard top rod for 7' door.
All rods easily field cut to size.
Optional door heights up to 8' available; see Quick Codes, page 55.
For door heights above 8'0" refer to ED5470(B).

Latchbolt

Top: 3/4" (19mm) throw, stainless steel pullman-type with automatic deadlatching.
Bottom: 5/8" (16mm) throw deadbolt, held retracted during door swing.

Vertical Rods

1/2" O.D. tubular brass, bronze or stainless steel with rod guides.

Materials

Heavy-duty cold-forged steel chassis; heavy-gauge steel mechanisms, electroplated for corrosion resistance; finished parts are brass, bronze or stainless steel; stainless steel springs; nylon bearings.

Projection

3-1/4" (83mm) active, 2-3/4" (70mm) dogged.

Dogging

Standard on panic devices; single-point 1/4 turn hex key dogging. Optional: less dogging, specify M51. Optional: cylinder dogging, specify M52. Optional: electric dogging; specify M97. Mechanical dogging not available on fire-rated devices.

ED5000.10

Fasteners

Standard on panic devices: machine screws and wood door fasteners.
Standard on fire-rated devices: sex nuts and bolts.
Optional on panic devices: sex nuts and bolts for use on wood, composite, or unreinforced metal doors; specify M54.
Optional wood screws for use on approved fire-rated solid wood or wood core doors. Specify M64.

Strike

Top: adjustable roller strike with positive locking plate and shims.
Bottom: flush mounted.
Optional strikes available; see Options and Accessories, page 50.

Functions and Trims

Through-bolted lever, knob pull and thumbpiece trims available with wide range of functions; see Trims and Functions, pages 20-25.

Cylinders

Cylinder not included unless specified. See Quick Codes, page 53.

Shim Kit

Optional for mounting device over raised vision light molding; specify M58.

Applications and Listings

See page 4.

Warranty

Five-year limited.

Certification/Compliance

ANSI

Meets A156.3, Type 2, Grade 1.

UL/cUL

All devices listed for safety as panic hardware; devices comply with UL 305 standards for panic hardware. Three-hour fire-rated devices listed as fire exit hardware for A label and lesser class 8' x 8' double doors; UL symbol on active case cover indicates listing.

Any retrofit or other field modification to a fire-rated opening can potentially impact the fire rating of the opening, and Corbin Russwin, Inc. makes no representations or warranties

concerning what such impact may be in any specific situation. When retrofitting any portion of an existing fire rated opening, or specifying and installing a new fire-rated opening, please consult with a code specialist or local code official (Authority Having Jurisdiction) to ensure compliance with all applicable codes and ratings.

California State Reference Code

This product has been approved by the California State Fire Marshal pursuant to section 13144.1 of the California Health and Safety Code.

NFPA

All exit devices comply with NFPA 101 Life Safety Code. All fire-rated devices comply with NFPA 80 Fire Doors and Windows.

ADA

Lever trims and pulls comply with Americans with Disabilities Act.

Finishes

BHMA 605	Bright Brass
BHMA 606	Satin Brass
BHMA 611	Bright Bronze
BHMA 612	Satin Bronze
BHMA 613	Oxidized Bronze, oil rubbed, available lacquered
613E	Dark Oxidized Satin Bronze Equivalent
BHMA 618	Bright Nickel Plated
BHMA 619	Satin Nickel Plated
BHMA 625	Bright Chromium Plated
BHMA 626* (Trim only)	Satin Chromium Plated
626C	Satin Chromium Plated with MicroShield®
BHMA 629	Bright Stainless Steel
BHMA 630	Satin Stainless Steel
630C	Satin Stainless Steel with MicroShield®
BHMA 722	Black oxidized bronze, oil rubbed

*Contact factory for devices required in BHMA 626

Surface Vertical Rod Features

ED5000

ED5400 and ED5400A Surface Vertical Rod Exit Device

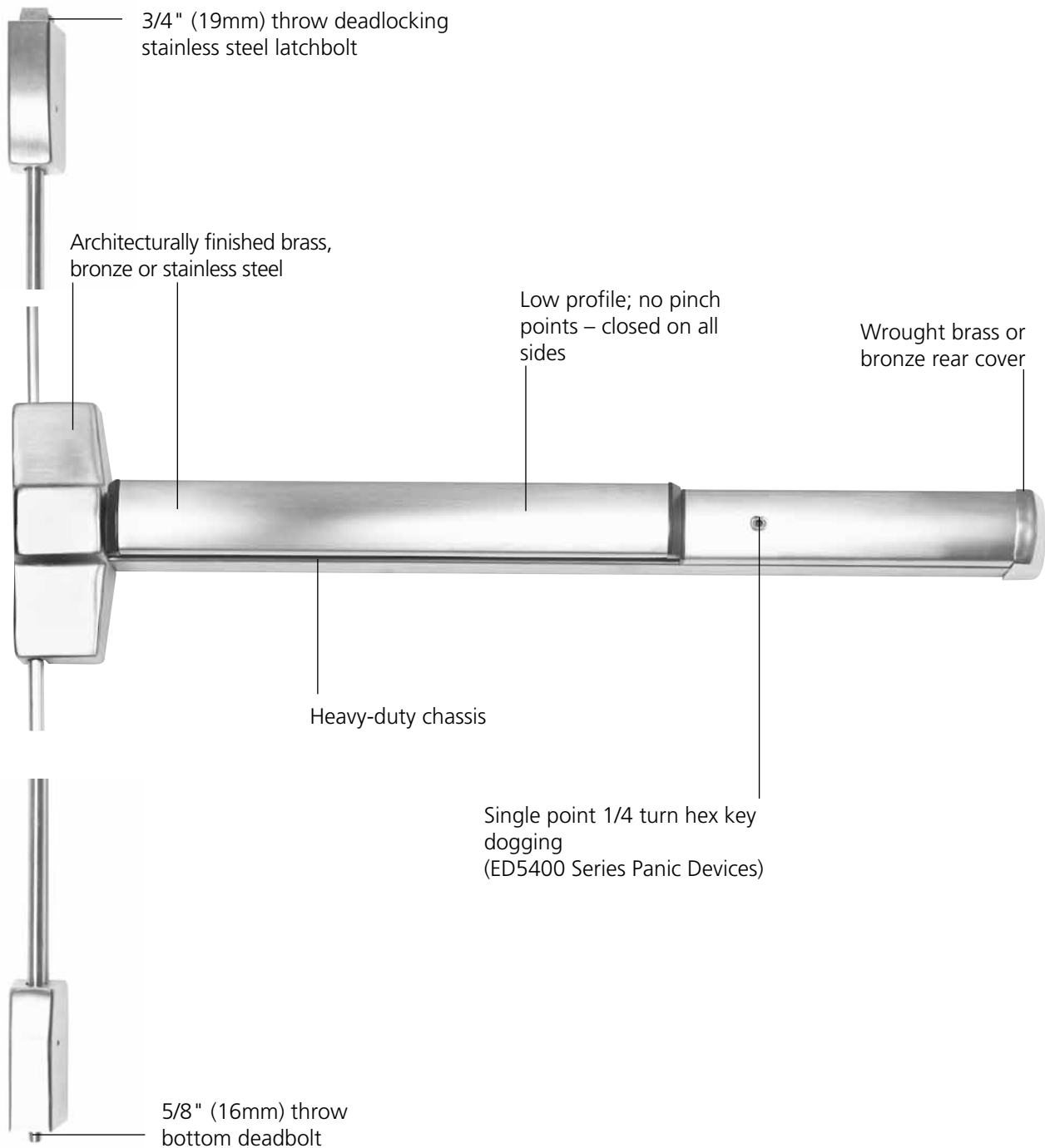

Surface Vertical Rod Features

ED5000

ED5470 Panic-Listed Surface Vertical Rod Exit Device ED5470B 1-1/2 Hour Fire-Listed Surface Vertical Rod Exit Device

Features

Handing

Device is handed but easily field reversible.
Lever trim is handed.

Bar length

Easily field cut to size.
Standard: 36" (914mm) bar fits 30" - 36" (762mm-914mm) door.
Optional: 24" (610mm) bar fits 24" (610mm) door; specify W024.
Optional: 48" (1219mm) bar fits 36" - 48" (914mm-1219mm) door; specify W048.

Door Thickness

1-3/4" (44mm) standard.
Optional: 2" (51mm); specify D200.
Optional: 2-1/4" (57mm); specify D214.

Stile

Minimum width 4-1/2" (14mm).

Door Height

Standard top rod for 7' door.
All top rods easily field cut to size.
Optional door heights up to 10' available; see Quick Codes, page 55.

Latchbolt

Top: 3/4" (19mm) throw, stainless steel, pullman-type with automatic deadlatching.
Bottom: 5/8" (16mm) throw deadbolt, held retracted during door swing.

Vertical Rods

1/2" O.D. tubular brass, bronze or stainless steel with rod guides.

Less Bottom Rod

Optional on ED5470 & ED5470B devices only; specify M55.

Heat Activated Door Bolt (Popper)

Standard on all fire-rated devices with M55 option (less bottom rod).

Materials

Heavy-duty cold-forged steel chassis; heavy-gauge steel mechanisms, electroplated for corrosion resistance; finished parts are brass, bronze or stainless steel; stainless steel springs; nylon bearings.

Projection

3-1/4" (83mm) active, 2-3/4" (70mm) dogged.

Dogging

Standard on panic devices; single-point 1/4 turn hex key dogging. Optional: less dogging, specify M51. Optional: cylinder dogging, specify M52. Optional: electric dogging; specify M97. Mechanical dogging not available on fire-rated devices.

Fasteners

Standard on panic devices: machine screws and wood door fasteners. Standard on fire-rated devices: sex nuts and bolts. Optional on panic devices: sex nuts and bolts for use on wood, composite, or unreinforced metal doors; specify M54. Optional wood screws for use on approved fire-rated solid wood or wood core doors. Specify M64.

Strike

Top: surface mounted interlocking.
Bottom: flush mounted.
Optional strikes available; see Options and Accessories, page 50.

Functions and Trims

Through-bolted lever, knob, pull and thumbpiece trims available with wide range of functions; see Trims and Functions, pages 20-25.

Cylinders

Cylinder not included unless specified. See Quick Codes, page 53.

Shim Kit

Optional for mounting device over raised vision light molding; specify M58.

Applications and Listings

See page 4.

Warranty

Five-year limited.

Certification/Compliance

ANSI

Meets A156.3, Type 2, Grade 1.
Meets A117.1 Accessibility Code when ordered with M55 option only.

UL/cUL

All devices listed for safety as panic hardware; devices comply with UL 305 standards for panic hardware. 1-1/2 hour fire-rated devices listed as fire exit hardware for B label and lesser class 8' x 10' double doors; UL symbol on active case cover indicates listings.

Any retrofit or other field modification to a fire rated opening can potentially impact the fire rating of the opening, and Corbin Russwin, Inc. makes no representations or warranties concerning what such impact may be in any specific situation. When retrofitting any portion of an existing fire rated opening, or specifying and installing a new fire-rated opening, please consult with a code specialist or local code official (Authority Having Jurisdiction) to ensure compliance with all applicable codes and ratings.

California State Reference Code

This product has been approved by the California State Fire Marshal pursuant to section 13144.1 of the California Health and Safety Code.

NFPA

All exit devices comply with NFPA 101 Life Safety Code.
All fire-rated devices comply with NFPA 80 Fire Doors and Windows.

ADA

Exit devices with M55 option, lever trims and pulls comply with Americans with Disabilities Act.

Finishes

BHMA 605	Bright Brass
BHMA 606	Satin Brass
BHMA 611	Bright Bronze
BHMA 612	Satin Bronze
BHMA 613	Oxidized Bronze, oil rubbed, available lacquered
613E	Dark Oxidized Satin Bronze Equivalent
BHMA 618	Bright Nickel Plated
BHMA 619	Satin Nickel Plated
BHMA 625	Bright Chromium Plated
BHMA 626* (Trim only)	Satin Chromium Plated
626C	Satin Chromium Plated with MicroShield®
BHMA 629	Bright Stainless Steel
BHMA 630	Satin Stainless Steel
630C	Satin Stainless Steel with MicroShield®
BHMA 722	Black oxidized bronze, oil rubbed

*Contact factory for devices required in BHMA 626

Surface Vertical Rod Features

ED5000

ED5470 and ED5470B Surface Vertical Rod Exit Devices

3/4" (19mm) throw deadlocking
stainless steel latchbolt



Architecturally finished brass,
bronze or stainless steel



Low profile; no pinch
points – closed on all
sides

Wrought brass or
bronze rear cover

Heavy-duty chassis

Single point 1/4 turn hex key dogging
(ED5470 Series Panic Devices)



5/8" (16mm) throw
deadbolt

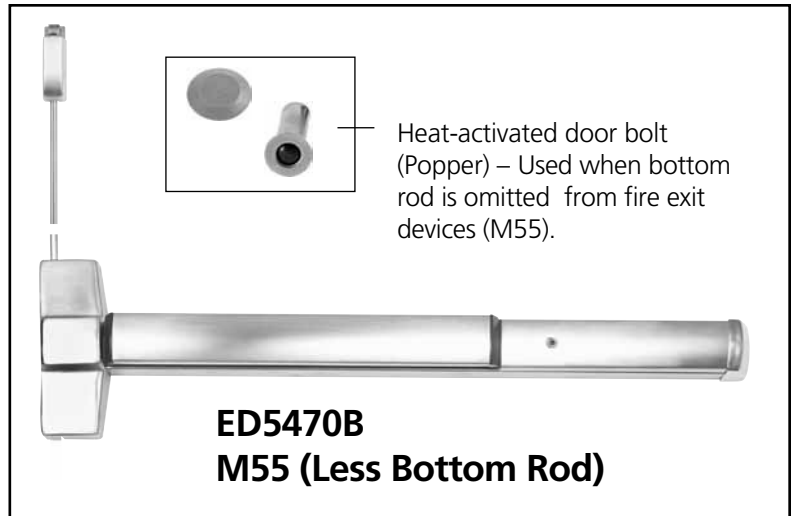

Concealed Vertical Rod Features

ED5000

ED5800 Panic-Listed Concealed Vertical Rod Exit Device ED5800A 3-Hour Fire-Listed Concealed Vertical Rod Exit Device

FOR USE WITH METAL DOORS ONLY

Features

Handing

Device is handed but easily field reversible.
Lever trim is handed.

Bar length

Easily field cut to size.
Standard: 36" (914mm) bar fits 30" - 36" (762mm-914mm) door.
Optional: 24" (610mm) bar fits 24" (610mm) door; specify W024.
Optional: 48" (1219mm) bar fits 36" -48" (914mm-1219mm) door; specify W048.

Door Thickness

1-3/4" (44mm) standard.
Optional: 2" (51mm); specify D200.
Optional: 2-1/4" (57mm); specify D214.

Stile

Minimum width 4-1/2" (114mm).

Door Height

Standard: top rod for 8' door.
Telescoping rod assembly to accommodate various door heights. For door heights above 8'0", refer to ED5860(B).

Latchbolt

Top: 3/4" (19mm) throw, stainless steel pullman-type with automatic deadlatching.
Bottom: 5/8" (16mm) throw deadbolt, held retracted during door swing.

Vertical Rods

1/2" O.D. tubing, electroplated for corrosion resistance.

Materials

Heavy-duty cold-forged steel chassis; heavy-gauge steel mechanisms, electroplated for corrosion resistance; finished parts are brass, bronze or stainless steel; stainless steel springs; nylon bearings.

Projection

3-1/4" (83mm) active, 2-3/4" (70mm) dogged.

Dogging

Standard on panic devices; single-point 1/4 turn hex key dogging. Optional: less dogging, specify M51. Optional: cylinder dogging, specify M52. Optional: electric dogging; specify M97. Mechanical dogging not available on fire-rated devices.

Fasteners

Standard on panic devices: machine screws.
Standard on fire-rated devices: sex nuts and bolts.
Optional on panic devices: sex nuts and bolts for use on unreinforced metal doors; specify M54.

Strike

Top: roller type.
Bottom: flush mounted.
Optional strikes available; see Options and Accessories, page 50.

Functions and Trims

Through-bolted lever, knob, pull and thumbpiece trims available with wide range of functions; see Trims and Functions, pages 20-25.

Cylinders

Cylinder not included unless specified. See Quick Codes, page 53.

Shim Kit

Optional for mounting device over raised vision light molding; specify M58.

Applications and Listings

For use on metal doors only. See page 4.

Warranty

Five-year limited.

Certification/Compliance

ANSI

Meets A156.3, Type 8, Grade 1.
Meets A117.1 Accessibility Code.

UL/cUL

All devices listed for safety as panic hardware; devices comply with UL 305 standards for panic hardware. Three-hour fire-rated devices listed as fire exit hardware for A label and lesser class 8' x 8' double doors; UL symbol on active case cover indicates listing.

Any retrofit or other field modification to a fire rated opening can potentially impact the fire rating of the opening, and Corbin Russwin, Inc. makes no representations or warranties concerning what such impact may be in any specific situation. When retrofitting any portion of an existing fire rated opening, or specifying and installing a new fire-rated opening, please

consult with a code specialist or local code official (Authority Having Jurisdiction) to ensure compliance with all applicable codes and ratings.

California State Reference Code

This product has been approved by the California State Fire Marshal pursuant to section 13144.1 of the California Health and Safety Code.

NFPA

All exit devices comply with NFPA 101 Life Safety Code.
All fire-rated devices comply with NFPA 80 Fire Doors and Windows.

ADA

Exit devices, lever trims and pulls comply with Americans with Disabilities Act.

Finishes

BHMA 605	Bright Brass
BHMA 606	Satin Brass
BHMA 611	Bright Bronze
BHMA 612	Satin Bronze
BHMA 613	Oxidized Bronze, oil rubbed, available lacquered
613E	Dark Oxidized Satin Bronze Equivalent
BHMA 618	Bright Nickel Plated
BHMA 619	Satin Nickel Plated
BHMA 625	Bright Chromium Plated
BHMA 626* (Trim only)	Satin Chromium Plated
626C	Satin Chromium Plated with MicroShield® 
BHMA 629	Bright Stainless Steel
BHMA 630	Satin Stainless Steel
630C	Satin Stainless Steel with MicroShield® 
BHMA 722	Black oxidized bronze, oil rubbed

***Contact factory for devices required in BHMA 626**

Concealed Vertical Rod Features

ED5000

ED5800 and ED5800A Concealed Vertical Rod Exit Devices

FOR USE WITH METAL DOORS ONLY

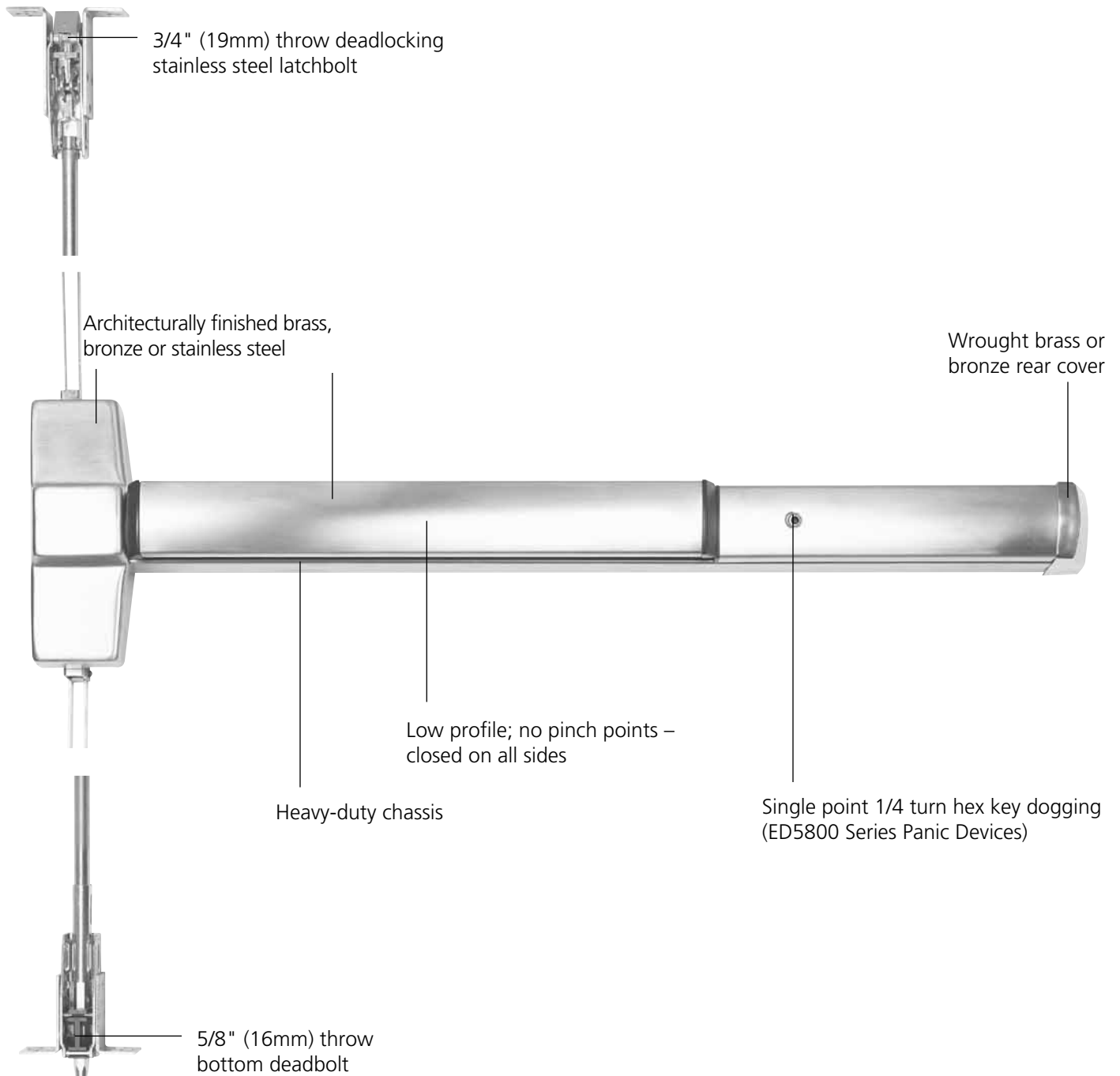

Concealed Vertical Rod Features

ED5000

ED5860 Panic-Listed Concealed Vertical Rod Exit Device ED5860B 1-1/2 Hour Fire-Listed Concealed Vertical Rod Exit Device

FOR USE WITH METAL OR WOOD DOORS

Features

Handing

Device is handed but is easily field reversible.
Lever trim is handed.

Bar length

Easily field cut to size.
Standard: 36" (914mm) bar fits 30" - 36" (762mm-914mm) door.
Optional: 24" (610mm) bar fits 24" (610mm) door; specify W024.
Optional: 48" (1219mm) bar fits 36" -48" (914mm-1219mm) door; specify W048.

Door Thickness

1-3/4" (14mm) standard.
Optional: 2" (51mm); specify D200.
Optional: 2-1/4" (57mm); specify D214.

Stile

Minimum width 4-1/2" (114mm).

Door Height

Standard: top rod for 8' door.
Telescoping rod assembly to accommodate various door heights.
Optional door heights up to 10' available; see Quick Codes, page 55.

Latchbolt

Top: 3/4" (19mm) throw, stainless steel, pullman-type with automatic deadlatching.
Bottom: 5/8" (16mm) throw deadbolt, held retracted during door swing.

Vertical Rods

1/2" O.D. tubing, electroplated for corrosion resistance.

Less Bottom Rod

Optional on ED5860 and ED5860B devices only; specify M55.

Heat-Activated Door Bolt (Popper)

Standard with all fire-rated devices with M55 option (less bottom rod).

Materials

Heavy-duty cold-forged steel chassis; heavy-gauge steel mechanisms, electroplated for corrosion resistance; finished parts are brass, bronze or stainless steel; stainless steel springs; nylon bearings.

Projection

3-1/4" (83mm) active, 2-3/4" (70mm) dogged.

ED5000.16

Dogging

Standard on panic devices; single-point 1/4 turn hex key dogging.
Optional: less dogging, specify M51.
Optional: cylinder dogging, specify M52.
Optional: electric dogging; specify M97.
Mechanical dogging not available on fire-rated devices.

Fasteners

Standard on panic devices: machine screws and wood door fasteners.
Standard on fire-rated devices: sex nuts and bolts.
Optional on panic devices: sex nuts and bolts for use on wood, composite, or unreinforced metal doors; specify M54.
Optional wood screws for use on approved fire-rated solid wood or wood core doors. Specify M64.

Strike

Top: mortise. Bottom: flush mounted.
Optional strikes available; see Options and Accessories, page 50.

Functions and Trims

Through-bolted lever, knob, pull and thumbpiece trims available with wide range of functions; see Trims and Functions, pages 20-25.

Cylinders

Cylinder not included unless specified. See Quick Codes, page 53.

Shim Kit

Optional for mounting device over raised vision light molding; specify M58.

Applications and Listings

For use with metal or wood doors. See page 4.

Warranty

Five-year limited.

Certification/Compliance

ANSI

Meets A156.3, Type 7 and 8, Grade 1.
Meets A117.1 Accessibility Code.

UL/cUL

All devices listed for safety as panic hardware; devices comply with UL 305 standards for panic hardware. 1-1/2 hour fire-rated devices listed as fire exit hardware for B label and lesser class 8' x 10' double doors; UL symbol on active case cover indicates listings.

Any retrofit or other field modification to a fire rated opening can potentially impact the fire rating of the opening, and Corbin Russwin, Inc. makes no representations or warranties concerning what such impact may be in any specific situation. When retrofitting any portion of an existing fire rated opening, or specifying and installing a new fire-rated opening, please consult with a code specialist or local code official (Authority Having Jurisdiction) to ensure compliance with all applicable codes and ratings.

California State Reference Code

This product has been approved by the California State Fire Marshal pursuant to section 13144.1 of the California Health and Safety Code.

NFPA



All exit devices comply with NFPA 101 Life Safety Code.

All fire-rated devices comply with NFPA 80 Fire Doors and Windows.

ADA

Exit devices, lever trims and pulls comply with Americans with Disabilities Act.

Finishes

BHMA 605	Bright Brass
BHMA 606	Satin Brass
BHMA 611	Bright Bronze
BHMA 612	Satin Bronze
BHMA 613	Oxidized Bronze, oil rubbed, available lacquered
613E	Dark Oxidized Satin Bronze Equivalent
BHMA 618	Bright Nickel Plated
BHMA 619	Satin Nickel Plated
BHMA 625	Bright Chromium Plated
BHMA 626* (Trim only)	Satin Chromium Plated
626C	Satin Chromium Plated with MicroShield® 
BHMA 629	Bright Stainless Steel
BHMA 630	Satin Stainless Steel
630C	Satin Stainless Steel with MicroShield® 
BHMA 722	Black oxidized bronze, oil rubbed

***Contact factory for devices required in BHMA 626**

Concealed Vertical Rod Features

ED5000

ED5860 and ED5860B Concealed Vertical Rod Exit Devices

FOR USE WITH METAL OR
WOOD DOORS

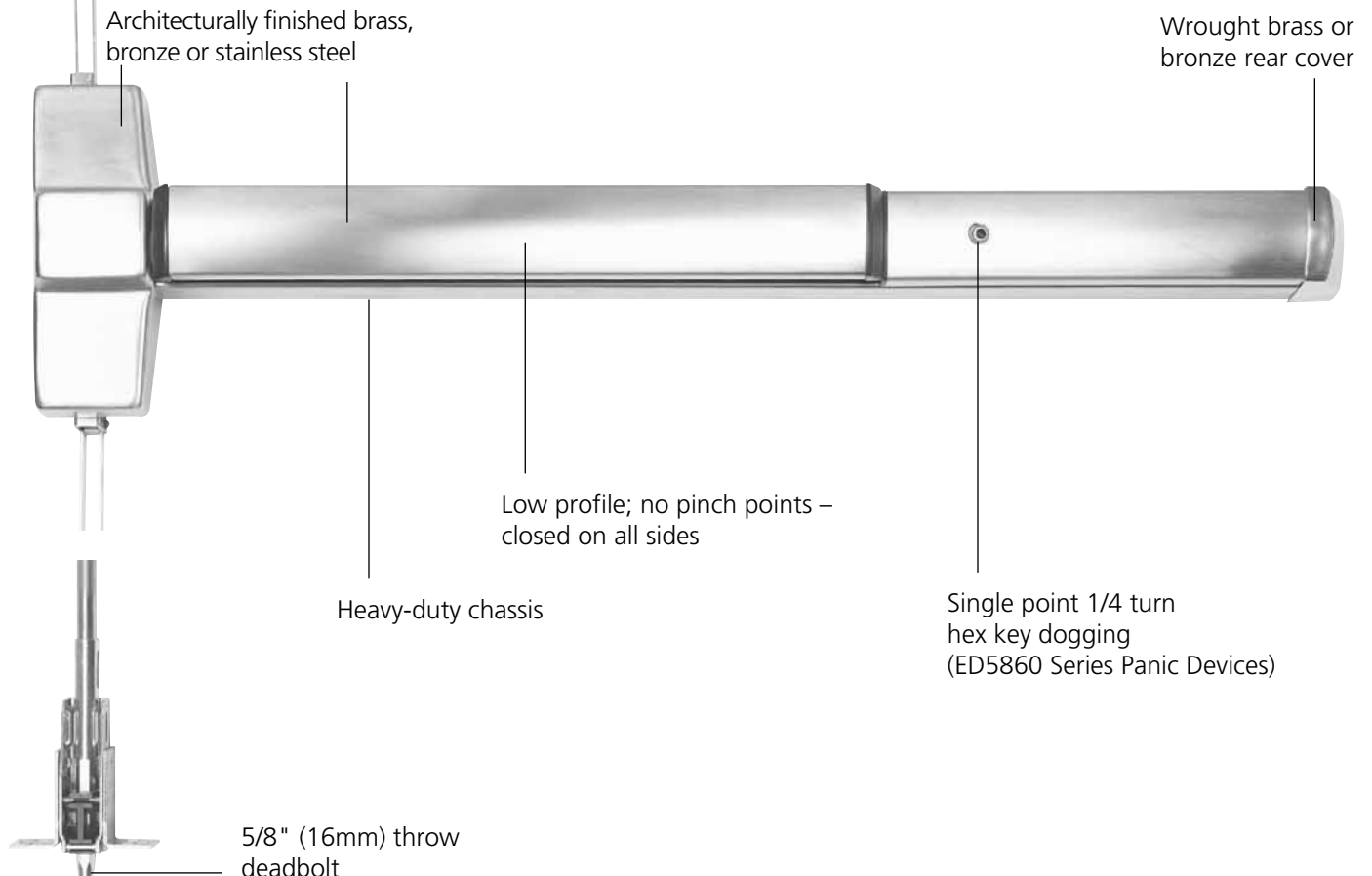
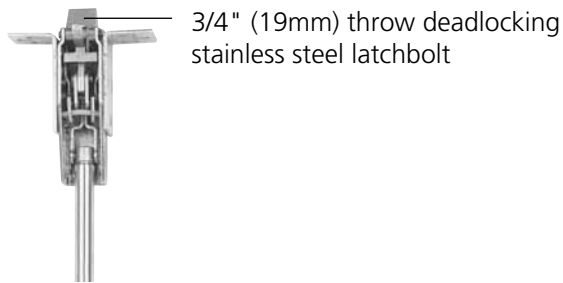
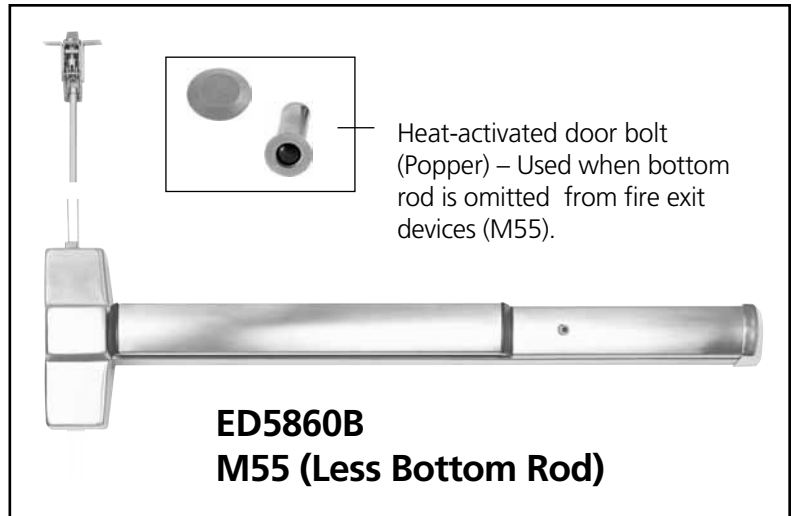

Functions

ED5000

Pull and Thumbpiece Trim











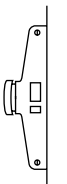

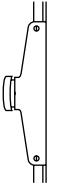



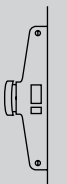



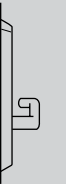
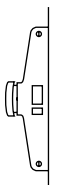

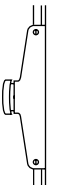

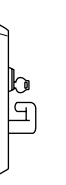
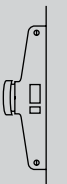
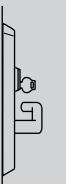

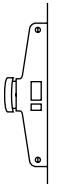
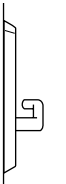
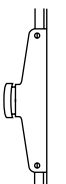

Rim/ SecureBolt® ED5200(A) ED5200S(A)		Surface Vertical Rod ED5400(A) ED5470(B)		Concealed Vertical Rod ED5800(A) ED5860(B)		Type	ANSI No.	Function Description
Inside	Outside	Inside	Outside	Inside	Outside			
						Exit Only	01	Exit only; no trim.
						Dummy	02	Entrance by trim when actuating bar is dogged down.
						Nightlatch	03	Entrance by trim when latchbolt is retracted by key.
						Classroom*	05	Entrance by thumbpiece. Key locks or unlocks thumbpiece.
						Passage	15	Entrance by trim when latch is retracted by thumbpiece. Thumbpiece is always active, no cylinder.
						Storeroom (Thumbpiece Active)	06	Entrance by thumbpiece only when released by key. Key removable only when locked.

*Classroom function trims can be converted to Storeroom function by a simple field adjustment.

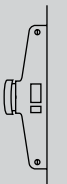
Functions

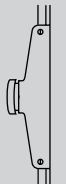
ED5000

Lever and Knob Trim

Rim/ SecureBolt® ED5200(A) ED5200S(A)		Surface Vertical Rod ED5400(A) ED5470(B)		Concealed Vertical Rod ED5800(A) ED5860(B)		Type	ANSI No.	Function Description
Inside	Outside	Inside	Outside	Inside	Outside			
						Exit Only	01	Exit only; no trim.
						Dummy	02	Entrance by trim when actuating bar is dogged down.
						Nightlatch	03	Entrance by trim when latchbolt is retracted by key.
						Classroom*	08	Entrance by knob or lever. Key locks or unlocks knob or lever.
						Passage	14	Entrance by trim when latchbolt is retracted by knob or lever. Knob or lever always active, no cylinder.
						Storeroom (Grip Active)	09	Entrance by knob or lever only when released by key. Key removable only when locked.

*Classroom function trims can be converted to Storeroom function by a simple field adjustment.

Heavy-Duty Trims & Functions







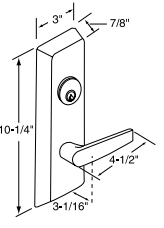

ED5000

Rim, SecureBolt®, Vertical Rod

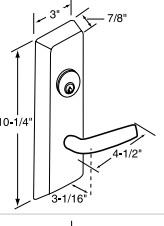
Features:

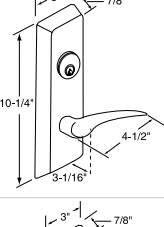
- Free Wheeling vandal-resistant design
- Beveled edges

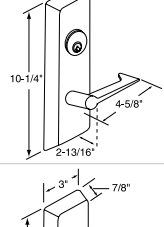
- Through-bolted to exit device
- Flush cylinder with 6-pin cylinder applications
- 5-year limited warranty

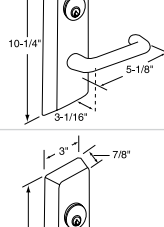
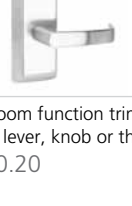
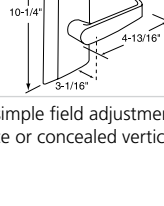
Pull Trim Design	Trim/Function				
	Passage ANSI No. 14	Dummy ANSI No. 02	Classroom ANSI No. 08	Nightlatch ANSI No. 03	Storeroom ANSI No. 09
 <p>Armstrong A9 Lever: Cast Escutcheon: Forged Cylinder: Rim</p> 	A910	A950	A955 ¹	A957 ²	A959 ¹
 <p>Citation C9 Lever: Cast Escutcheon: Forged Cylinder: Rim</p> 	C910	C950	C955 ¹	C957 ²	C959 ¹
 <p>Dirke D9 Lever: Cast Escutcheon: Forged Cylinder: Rim Handed: Specify RHR or LHR</p> 	D910	D950	D955 ¹	D957 ²	D959 ¹
 <p>Essex E9 Lever: Cast Escutcheon: Forged Cylinder: Rim</p> 	E910	E950	E955 ¹	E957 ²	E959 ¹
 <p>Lustra L9 Lever: Cast Escutcheon: Forged Cylinder: Rim</p> 	L910	L950	L955 ¹	L957 ²	L959 ¹
 <p>Newport N9 Lever: Cast Escutcheon: Forged Cylinder: Rim</p> 	N910	N950	N955 ¹	N957 ²	N959 ¹

1. Classroom function trims can be converted to Storeroom function by a simple field adjustment.

2. Active lever, knob or thumbpiece trim recommended for use with surface or concealed vertical rod exit devices.

Heavy-Duty Trims & Functions





ED5000

Rim, SecureBolt®, Vertical Rod

Features:

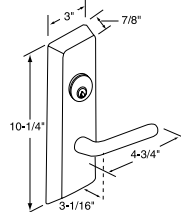
- Free Wheeling vandal-resistant design
- Beveled edges

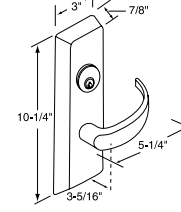
- Through-bolted to exit device
- Flush cylinder with 6-pin cylinder applications
- 5-year limited warranty

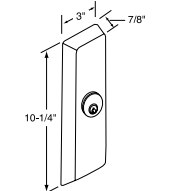
Pull Trim Design		Trim/Function					
		Passage ANSI No. 14	Dummy ANSI No. 02	Classroom ANSI No. 08	Nightlatch ANSI No. 03	Storeroom ANSI No. 09	
	Regis R9 Lever: Cast Escutcheon: Forged Cylinder: Rim		R910	R950	R955 ¹	R957 ²	R959 ¹
	Princeton PR9 Lever: Cast Escutcheon: Forged Cylinder: Rim		PR910	PR950	PR955 ¹	PR957 ²	PR959 ¹
	Escutcheon F9 Escutcheon: Forged Cylinder: Rim		N/A	F950	N/A	F957 ²	N/A

1. Classroom function trims can be converted to Storeroom function by a simple field adjustment.
2. Active lever, knob or thumbpiece trim recommended for use with surface or concealed vertical rod exit devices.

Utility Trims and Functions









ED5000

Rim, SecureBolt®, Vertical Rod

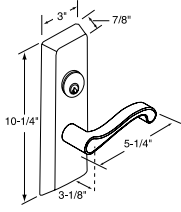
Features:

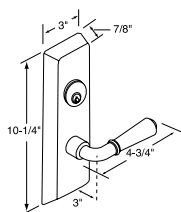
- Free Wheeling vandal-resistant design
- Beveled edges

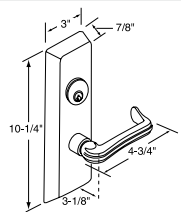
- Through-bolted to exit device
- Flush cylinder with 6-pin cylinder applications
- 5-year limited warranty

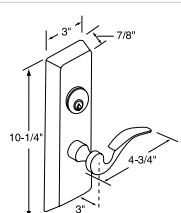
Pull Trim Design			Trim/Function					
			Passage ANSI No. 14	Dummy ANSI No. 02	Classroom ANSI No. 08	Nightlatch ANSI No. 03	Storeroom ANSI No. 09	
	Frascati FR9 Lever: Cast Escutcheon: Forged Cylinder: Rim Handed: Specify RHR or LHR			FR910	FR950	FR955 ¹	FR957 ²	FR959
	Merlot M9 Lever: Cast Escutcheon: Forged Cylinder: Rim			M910	M950	M955 ¹	M957 ²	M959
	Tuscany TS9 Lever: Cast Escutcheon: Forged Cylinder: Rim			TS910	TS950	TS955 ¹	TS957 ²	TS959
	Zinfandel Z9 Lever: Cast Escutcheon: Forged Cylinder: Rim Handed: Specify RHR or LHR			Z910	Z950	Z955 ¹	Z957 ²	Z959

1. Classroom function trims can be converted to Storeroom function by a simple field adjustment.

2. Active lever, knob or thumbpiece trim recommended for use with surface or concealed vertical rod exit devices.

Utility Trims and Functions









ED5000

Rim, SecureBolt®, Vertical Rod

Features:

- Free Wheeling vandal-resistant design
- Beveled edges

- Through-bolted to exit device
- Flush cylinder with 6-pin cylinder applications
- 5-year limited warranty

Pull Trim Design	Trim/Function				
	Passage ANSI No. 14/15	Dummy ANSI No. 02	Classroom ANSI No. 05/08	Nightlatch ANSI No. 03	Storeroom ANSI No. 06/09
 <p>G900 Trim Knob: Wrought Escutcheon: Forged Cylinder: Rim</p>					
 <p>TH900 Trim  Pull: Extruded Escutcheon: Forged Cylinder: Rim Projection: 2-11/16"</p>					
 <p>Offset Pull P9  Pull: Extruded Escutcheon: Forged Cylinder: Rim Handed. Specify RHR or LHR</p>					
 <p>VT9 Trim  Plate: Formed Stainless Steel Cylinder: Rim Handed: Specify RHR or LHR</p>					
 <p>Key Only K1  Note: Available with cylinder option only. Ex: K157 x 6P.</p>					

1. Classroom function trims can be converted to Storeroom function by a simple field adjustment.







2. Not recommended for use on ED5400 or ED5800 series exit devices.

3. VTL has a lip that covers door gap and protects the latch.

Utility Trims and Functions

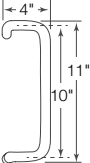
ED5000

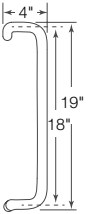
Offset Pull Trim: P12, P13, P14*

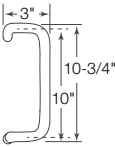
	<p>Offset Pull P12 Clearance: 2-1/2" </p>		<p>Specify Part Number, 716F50M x Finish¹</p>
	<p>Offset Pull P13 Clearance: 2-1/2" </p>		<p>Specify Part Number, 716F51M x Finish¹</p>
	<p>Offset Pull P14 Clearance: 2-1/2" </p>		<p>Specify Part Number, 716F52M x Finish¹</p>

1. Available in 605, 606, 612, 613, 626, 629 and 630 finishes.

*Available on 1-3/4" thick doors only.

Utility Trims and Functions



































ED5000

Rim, SecureBolt®, Vertical Rod Features:

- Free Wheeling vandal-resistant design
- Beveled edges
- Through-bolted to exit device
- Flush cylinder with 6-pin cylinder applications
- 5-year limited warranty



Lever: Cast
Escutcheon: Forged
Cylinder: Rim

Pull Trim Design	Trim/Function						
	Passage ANSI No. 14	Dummy ANSI No. 02	Classroom ANSI No. 08	Nightlatch ANSI No. 03	Storeroom ANSI No. 09		
Muséo®							
GEORGIA	102	102910	102950	102955 ¹	102957	102959 ¹	    
	103	103910	103950	103955 ¹	103957	103959 ¹	
	104	104910	104950	104955 ¹	104957	104959 ¹	
	124	124910	124950	124955 ¹	124957	124959 ¹	
	125	125910	125950	125955 ¹	125957	125959 ¹	
SALVADOR	106	106910	106950	106955 ¹	106957	106959 ¹	       
	107	107910	107950	107955 ¹	107957	107959 ¹	
	108	108910	108950	108955 ¹	108957	108959 ¹	
	109	109910	109950	109955 ¹	109957	109959 ¹	
	110	110910	110950	110955 ¹	110957	110959 ¹	
	123	123910	123950	123955 ¹	123957	123959 ¹	
	128	128910	128950	128955 ¹	128957	128959 ¹	
	129	129910	129950	129955 ¹	129957	129959 ¹	
MARC	111	111910	111950	111955 ¹	111957	111959 ¹	        
	112	112910	112950	112955 ¹	112957	112959 ¹	
	113	113910	113950	113955 ¹	113957	113959 ¹	
	114	114910	114950	114955 ¹	114957	114959 ¹	
	115	115910	115950	115955 ¹	115957	115959 ¹	
	116	116910	116950	116955 ¹	116957	116959 ¹	
	130	130910	130950	130955 ¹	130957	130959 ¹	
	131	131910	131950	131955 ¹	131957	131959 ¹	
	132	132910	132950	132955 ¹	132957	132959 ¹	
PABLO	117	117910	117950	117955 ¹	117957	117959 ¹	 
	126	126910	126950	126955 ¹	126957	126959 ¹	
JACKSON	119	119910	119950	119955 ¹	119957	119959 ¹	   
	121	121910	121950	121955 ¹	121957	121959 ¹	
	122	122910	122950	122955 ¹	122957	122959 ¹	
PIET*	127	127910	127950	127955 ¹	127957	127959 ¹	     
	21L	21L910	21L950	21L955 ¹	21L957	21L959 ¹	
	21M	21M910	21M950	21M955 ¹	21M957	21M959 ¹	
	21S	21S910	21S950	21S955 ¹	21S957	21S959 ¹	
	21W	21W910	21W950	21W955 ¹	21W957	21W959 ¹	
	23M	23M910	23M950	23M955 ¹	23M957	23M959 ¹	
25M	25M910	25M950	25M955 ¹	25M957	25M959 ¹		

*See pages 59-60 for how to order the Muséo® Piet Lever Collection.

1. Classroom function trims can be converted to Storeroom function by a simple field adjustment.

2. Active lever, knob or thumbpiece trim recommended for use with surface or concealed vertical rod exit devices

Mortise Features

ED5000

- ED5600** **Panic-Listed Mortise Exit Device**
ED5600A **3-Hour Fire-Listed Mortise Exit Device**
ED5602L **Panic-Listed Listed Mortise Double Cylinder Exit Device**
ED5602AL **3-Hour Fire-Listed Mortise Double Cylinder Exit Device**



Features

Handing

Device is non-handed.
Mortise lock body is handed, but field reversible.
Lever trim may be handed.

Bar length

Easily field cut to size.
Standard: 36" (914mm) bar fits 30" - 36" (762mm-914mm) door.
Optional: 24" (610mm) bar fits 24" (610mm) door; specify W024.
Optional: 48" (1219mm) bar fits 36" -48" (914mm-1219mm) door; specify W048.

Door Thickness

1-3/4" (44mm) standard.
Optional: 2" (51mm); specify D200.
Optional: 2-1/4" (57mm); specify D214.

Stile

Minimum width 4-1/2" (114mm).

Latchbolt

2-piece mechanical, 3/4" (19mm) throw, stainless steel with auxiliary deadlocking latch.

Materials

Heavy-duty cold-forged steel chassis; heavy-gauge steel mechanisms, electroplated for corrosion resistance; finished parts are brass, bronze or stainless steel; stainless steel springs; nylon bearings.

Projection

3-1/4" (83mm) active, 2-3/4" (70mm) dogged.

Dogging

Standard on panic devices; single-point 1/4 turn hex key dogging.
Optional: less dogging, specify M51.
Optional: cylinder dogging, specify M52.
Optional: electric dogging; specify M97.
Mechanical dogging not available on fire-rated devices.

Fasteners

Standard on panic devices: machine screws and wood door fasteners.
Standard on fire-rated devices: sex nuts and bolts.
Optional on panic devices: sex nuts and bolts for use on wood, composite, or unreinforced metal doors; specify M54.
Optional wood screws for use on approved fire-rated solid wood or wood core doors. Specify M64.

Strike

Non-handed. ANSI curved lip standard. 4-7/8" x 1-1/4" x 1-1/4" lip to center.
Optional strikes available; see Options and Accessories, page 51.

Functions and Trims

Through-bolted lever, knob, pull and thumbpiece trims available with wide range of functions; see Trims and Functions, pages 30-35.

Cylinders

Cylinder not included unless specified. See Quick Codes, page 53.

Shim Kit

Optional for mounting device over raised vision light molding; specify M58.

Applications and Listings

See page 4.

Warranty

Five-year limited.

Certification/Compliance

ANSI

Meets A156.3, Type 3, Grade 1.
Meets A117.1 Accessibility Code.

UL/cUL

All devices listed for safety as panic hardware; devices comply with UL 305 standards for panic hardware. Three-hour fire-rated devices listed as fire exit hardware for A label and lesser class 4' x 8' single or 8' x 8' double doors; UL symbol on active case cover indicates listings.

Any retrofit or other field modification to a fire rated opening can potentially impact the fire rating of the opening, and Corbin Russwin, Inc. makes no representations or warranties concerning what such impact may be in any specific situation. When retrofitting any portion of an existing fire rated opening, or specifying and installing a new fire-rated opening, please consult with a code specialist or local code official (Authority Having Jurisdiction) to ensure compliance with all applicable codes and ratings.

California State Reference Code

This product has been approved by the California State Fire Marshal pursuant to section 13144.1 of the California Health and Safety Code.

NFPA



All exit devices comply with NFPA 101 Life Safety Code.

All fire-rated devices comply with NFPA 80 Fire Doors and Windows.

ADA

Exit devices, lever trims and pulls comply with Americans with Disabilities Act.

Finishes

BHMA 605	Bright Brass
BHMA 606	Satin Brass
BHMA 611	Bright Bronze
BHMA 612	Satin Bronze
BHMA 613	Oxidized Bronze, oil rubbed, available lacquered
613E	Dark Oxidized Satin Bronze Equivalent
BHMA 618	Bright Nickel Plated
BHMA 619	Satin Nickel Plated
BHMA 625	Bright Chromium Plated
BHMA 626* (Trim only)	Satin Chromium Plated
626C	Satin Chromium Plated with MicroShield® 
BHMA 629	Bright Stainless Steel
BHMA 630	Satin Stainless Steel
630C	Satin Stainless Steel with MicroShield® 
BHMA 722	Black oxidized bronze, oil rubbed

***Contact factory for devices required in BHMA 626**

Mortise Features

ED5000

**ED5600K, ED5657K
ED5600L, ED5602L, ED5657L,
ED5602L, ED5600T, ED5657T
Mortise Panic-Listed Exit Devices**

**ED5600AK, ED5657AK
ED5600AL, ED5602AL, ED5657AL,
ED5602AL, ED5600AT, ED5657AT
Mortise Fire-Listed Exit Devices**



How to Order/Specify Mortise Exit

Trim Type	Functions	Panic	Fire
Knob	Passage	ED5600K	ED5600AK
	Classroom		
	Nightlatch	ED5657K	ED5657AK
	Dummy		
Lever or Flat Plate	Passage	ED5600L	ED5600AL
	Classroom		
	Double Cylinder (Classroom function Trim only)	ED5602L	ED5602AL
	Nightlatch	ED5657L	ED5657AL
Dummy			
Thumbpiece	Passage	ED5600T	ED5600AT
	Classroom		
	Nightlatch	ED5657T	ED5657AT
	Dummy		

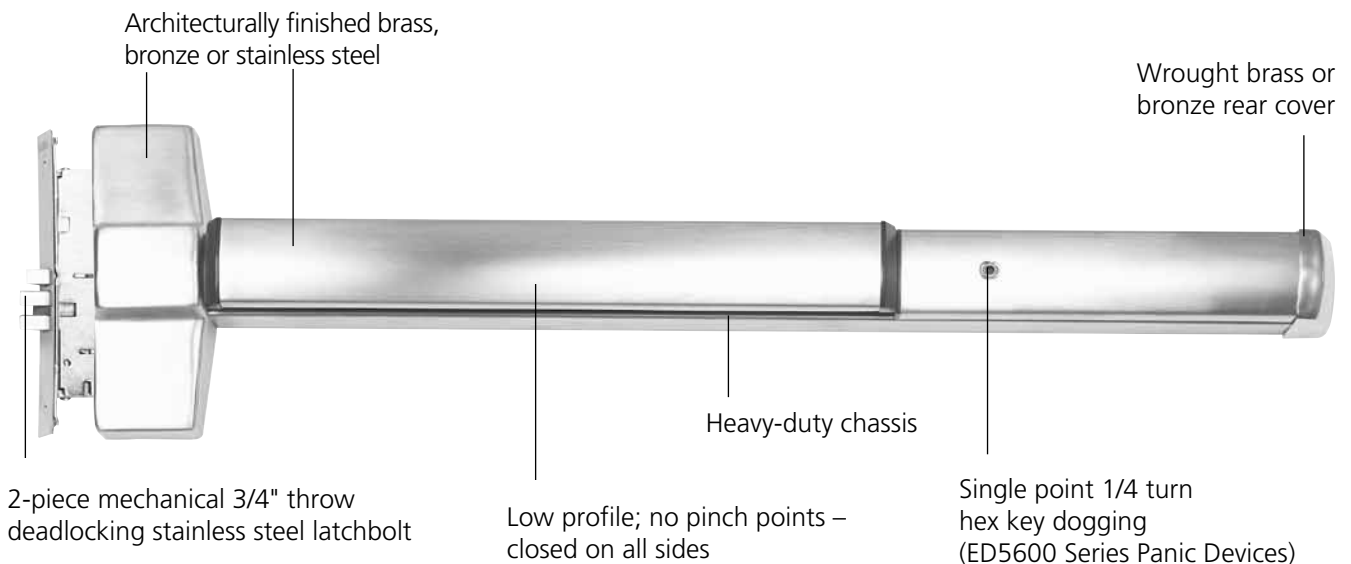

Mortise Functions

ED5000

Exit Only, Pull and Thumbpiece Trim

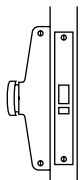
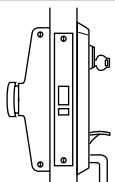
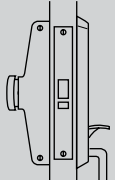
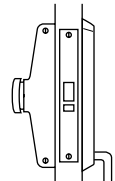
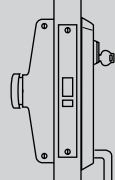
Mortise ED5600L ED5600AL		Type	ANSI No.	Function Description
Inside	Outside			
		Exit Only	01	Exit only; no trim.
Mortise ED5600T ED5600AT		Type	ANSI No.	Function Description
Inside	Outside			
		Classroom	05	Entrance by thumbpiece. Key locks or unlocks thumbpiece. Specify Thumbpiece - ED5600T or ED5600AT.
		Passage	15	Entrance by trim when latch is retracted by thumbpiece. Thumbpiece always active, no cylinder. Specify Thumbpiece - ED5600T or ED5600AT.
Mortise ED5657T ED5657AT		Type	ANSI No.	Function Description
Inside	Outside			
		Dummy	02	Entrance by trim when actuating bar is dogged down. Specify ED5657T or ED5657AT.
		Nightlatch	03	Entrance by trim when latchbolt is retracted by key. Key removable only when locked. Specify ED5657T or ED5657AT.

Mortise Functions

ED5000

Lever and Knob Trim

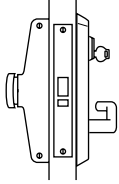
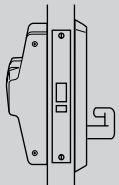
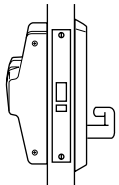
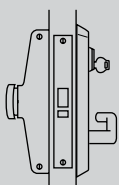
Mortise ED5600L ED5600AL ED5600K ED5600AK Inside Outside	Type	ANSI No.	Function Description
	Classroom**	08	Entrance by knob or lever. Key locks or unlocks knob or lever.
	Passage*	14	Entrance by trim when latchbolt is retracted by knob or lever. Knob or lever always active, no cylinder. Specify K, AK, L or AL.
Mortise ED5657L ED5657AL ED5657K ED5657AK Inside Outside	Type	ANSI No.	Function Description
	Dummy*	02	Entrance by trim when actuating bar is dogged down.
	Nightlatch**	03	Entrance by trim when latchbolt is retracted by key. Key removable only when locked. Specify ED5657L, ED5657AL, ED5657K, ED5657AK.

*Dummy and passage function trims are the same.













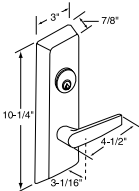

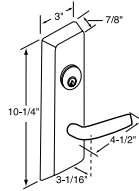

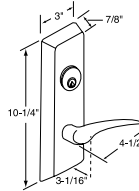
**Classroom and Nightlatch function trims are the same. Trim function must be specified when ordered with an exit to ensure that the correct lock body is supplied with the device.

Heavy-Duty Mortise Trims & Functions

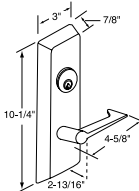
ED5000

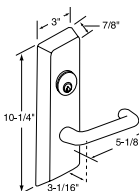
Features:

- Beveled edges
- Rigid lever when locked
- Flush cylinder
- Through-bolted to exit device
- 5-year limited warranty

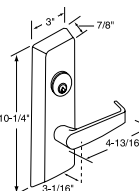







Trim Design	Trim/Function			
	Passage ANSI No. 14	Dummy ANSI No. 02	Classroom ANSI No. 08	Nightlatch ANSI No. 03
 <p>Armstrong A9M </p> <p>Lever: Cast Escutcheon: Forged Cylinder: 1-1/2" Mortise A02 </p> 	A9M10	A9M50	A9M55	A9M57
 <p>Citation C9M </p> <p>Lever: Cast Escutcheon: Forged Cylinder: 1-1/2" Mortise A02 </p> 	C9M10	C9M50	C9M55	C9M57
 <p>Dirke D9M </p> <p>Lever: Cast Escutcheon: Forged Cylinder: 1-1/2" Mortise A02 </p> <p>Handed: Specify RHR or LHR</p> 	D9M10	D9M50	D9M55	D9M57
 <p>Essex E9M </p> <p>Lever: Cast Escutcheon: Forged Cylinder: 1-1/2" Mortise A02 </p> 	E9M10	E9M50	E9M55	E9M57
 <p>Lustra L9M </p> <p>Lever: Cast Escutcheon: Forged Cylinder: 1-1/2" Mortise A02 </p> 	L9M10	L9M50	L9M55	L9M57
 <p>Newport N9M </p> <p>Lever: Cast Escutcheon: Forged Cylinder: 1-1/2" Mortise A02 </p> 	N9M10	N9M50	N9M55	N9M57

Heavy-Duty Mortise Trims & Functions

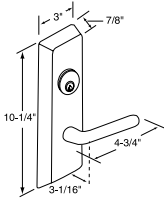
ED5000

Features:

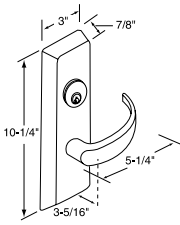
- Beveled edges
- Rigid lever when locked
- Flush cylinder
- Through-bolted to exit device
- 5-year limited warranty

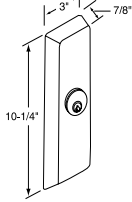











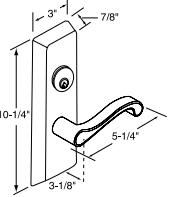

Trim Design			Trim/Function			
			Passage ANSI No. 14	Dummy ANSI No. 02	Classroom ANSI No. 08	Nightlatch ANSI No. 03
	<p>Regis R9M</p> <p>Lever: Cast Escutcheon: Forged Cylinder: 1-1/2 " Mortise A02 </p> 		R9M10	R9M50	R9M55	R9M57
	<p>Princeton PR9M</p> <p>Lever: Cast Escutcheon: Forged Cylinder: 1-1/2 " Mortise A02 </p> 		PR9M10	PR9M50	PR9M55	PR9M57
	<p>Escutcheon F9</p> <p>Escutcheon: Forged Cylinder: 1-1/2 " Mortise A02 </p>		N/A	F950	N/A	F9M57

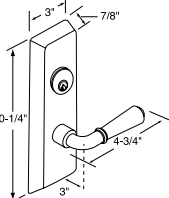
Heavy-Duty Mortise Trims & Functions

ED5000

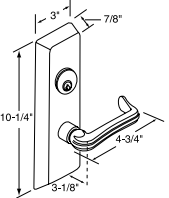
Features:

- Beveled edges
- Rigid lever when locked
- Flush cylinder
- Through-bolted to exit device
- 5-year limited warranty

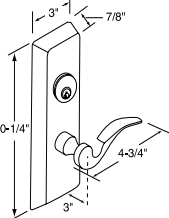
Trim Design		Trim/Function				
		Passage ANSI No. 14	Dummy ANSI No. 02	Classroom ANSI No. 08	Nightlatch ANSI No. 03	
	Fracati FR9M  Lever: Cast Escutcheon: Forged Cylinder: 1-1/2" Mortise A02  Handed: Specify RHR or LHR		FR9M10	FR9M50	FR9M55	FR9M57
	Merlot M9M  Lever: Cast Escutcheon: Forged Cylinder: 1-1/2" Mortise A02 		M9M10	M9M50	M9M55	M9M57
	Tuscany TS9M  Lever: Cast Escutcheon: Forged Cylinder: 1-1/2" Mortise A02 		TS9M10	TS9M50	TS9M55	TS9M57
	Zinfandel Z9M  Lever: Cast Escutcheon: Forged Cylinder: 1-1/2" Mortise A02  Handed: Specify RHR or LHR		Z9M10	Z9M50	Z9M55	Z9M57

Mortise Utility Trims & Functions













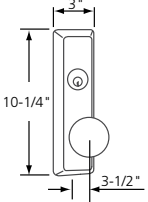

ED5000

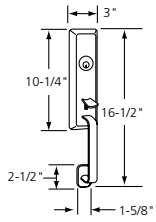
Mortise

Features:

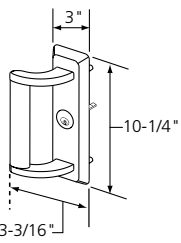
- Vandal-resistant design
- Beveled edges

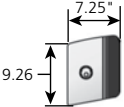
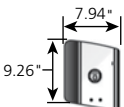
- Through-bolted to exit device
- Flush cylinder with 6-pin cylinder applications
- 5-year limited warranty







Pull Trim Design		Trim/Function				
		Passage ANSI No. 14/15	Dummy ANSI No. 02	Classroom ANSI No. 05/08	Nightlatch ANSI No. 03	
	G9M00 Trim Knob: Wrought Escutcheon: Forged Cylinder: 1-1/2" Mortise A02 		G9M10	G9M50	G9M55	G9M57
	TH9M00 Trim  Pull: Extruded Escutcheon: Forged Cylinder: 1-1/2" Mortise A02  Projection: 2-11/16"		TH9M10	TH9M50	TH9M55	TH9M57
	Offset Pull P9M  Pull: Extruded Escutcheon: Forged Cylinder: 1-1/2" Mortise A02  Handed: Specify RHR or LHR		N/A	P950	N/A	P9M57 (03)
	VT9M Trim  Plate: Formed Stainless Steel Cylinder: Mortise Handed: Specify RHR or LHR		N/A	VT950	N/A	VT9M57
			N/A	VTL950 ³	N/A	VTL9M57 ³
	Key Only K1M Note: Available with cylinder option only. Ex: K1M57 x 6P.		N/A	N/A	N/A	K1M57

3. VTL has a lip that covers door gap and protects the latch.

Mortise Utility Trims & Functions

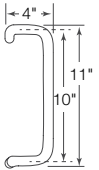
ED5000

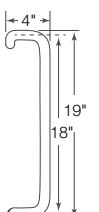
Offset Pull Trim: P12, P13, P14*

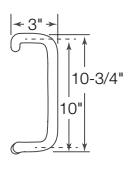
	<p>Offset Pull P12 Clearance: 2-1/2" </p>		<p>Specify Part Number, 716F50M x Finish¹</p>
	<p>Offset Pull P13 Clearance: 2-1/2" </p>		<p>Specify Part Number, 716F51M x Finish¹</p>
	<p>Offset Pull P14 Clearance: 2-1/2" </p>		<p>Specify Part Number, 716F52M x Finish¹</p>

1. Available in 605, 606, 612, 613, 626, 629 and 630 finishes.

* Available on 1 3/4" thick doors only.

Mortise Utility Trims & Functions



































ED5000

Mortise Features:

- Beveled edges
- Rigid lever when locked
- Through-bolted to exit device
- Flush cylinder
- 5-year limited warranty



Lever: Cast
Escutcheon: Forged
Cylinder: 1-1/2"
Mortise A02 

Pull Trim Design	Trim/Function					
	Passage ANSI No. 14	Dummy ANSI No. 02	Classroom ANSI No. 08	Nightlatch ANSI No. 03		
Muséo®						
GEORGIA	102	1029M10	1029M50	1029M55	1029M57	 102  103  104
	103	1039M10	1039M50	1039M55	1039M57	
	104	1049M10	1049M50	1049M55	1049M57	
	124	1249M10	1249M50	1249M55	1249M57	 124  125
	125	1259M10	1259M50	1259M55	1259M57	
SALVADOR	106	1069M10	1069M50	1069M55	1069M57	 106  107  108  109
	107	1079M10	1079M50	1079M55	1079M57	
	108	1089M10	1089M50	1089M55	1089M57	
	109	1099M10	1099M50	1099M55	1099M57	
	110	1109M10	1109M50	1109M55	1109M57	 110  123  128  129
	123	1239M10	1239M50	1239M55	1239M57	
	128	1289M10	1289M50	1289M55	1289M57	
129	1299M10	1299M50	1299M55	1299M57		
MARC	111	1119M10	1119M50	1119M55	1119M57	 111  112  113
	112	1129M10	1129M50	1129M55	1129M57	
	113	1139M10	1139M50	1139M55	1139M57	
	114	1149M10	1149M50	1149M55	1149M57	 114  115  116
	115	1159M10	1159M50	1159M55	1159M57	
	116	1169M10	1169M50	1169M55	1169M57	
	130	1309M10	1309M50	1309M55	1309M57	 130  131  132
	131	1319M10	1319M50	1319M55	1319M57	
132	1329M10	1329M50	1329M55	1329M57		
PABLO	117	1179M10	1179M50	1179M55	1179M57	 117  126
	126	1269M10	1269M50	1269M55	1269M57	
JACKSON	119	1199M10	1199M50	1199M55	1199M57	 119  121  122  127
	121	1219M10	1219M50	1219M55	1219M57	
	122	1229M10	1229M50	1229M55	1229M57	
127	1279M10	1279M50	1279M55	1279M57		
PIET*	21L	21L9M10	21L9M50	21L9M55	21L9M57	 21L  21M  21S
	21M	21M9M10	21M9M50	21M9M55	21M9M57	
	21S	21S9M10	21S9M50	21S9M55	21S9M57	 21W  23M  25M
	21W	21W9M10	21W9M50	21W9M55	21W9M57	
	23M	23M9M10	23M9M50	23M9M55	23M9M57	
	25M	25M9M10	25M9M50	25M9M55	25M9M57	

*See pages 59-60 for how to order the Muséo® Piet Lever Collection.

Electrified Exit Devices

ED5000

Electrified Exit Devices

The Corbin Russwin ED5000 series electrified exit devices offer a complete range of options that may be integrated into the monitoring security and alarm systems of most buildings. The continuum of appearance is maintained, as well as the security and function of the ED5000 mechanical exit device.



List No.	Exit Device Description	Available options										
		M61	M91	M92	M93	M94	M97	SAF	SEC	D	9903	9905
ED5200 (A)	Rim Exit Device	x	x	x	x	x	x			x	x	x
ED5200S (A)	Rim SecureBolt® Device	x	x	x	x	x	x			x	x	x
ED5400 (A)	Surface Vertical Rod	x	x	x	x	x	x			x	x	x
ED5470 (B)	Surface Vertical Rod	x	x	x	x	x	x			x	x	x
ED5600 (A)	Mortise Exit Device	x	x	x		x	x	x	x	x		
ED5800 (A)	Concealed Vertical Rod	x	x	x	x	x	x			x	x	x
ED5860 (B)	Concealed Vertical Rod	x	x	x	x	x	x			x	x	x

Electrified Hardware Option Descriptions

M61	Alarm Option
M91	Bolt Monitor
M92	Touchbar Monitor
M93	Trim Monitor
M94	Latch Retraction
M97	Electric Dogging
SAF	Fail Safe Operation
SEC	Fail Secure Operation
D*	Delayed Egress ²
9903	Fail Safe Electrified Trim
9905	Fail Secure Electrified Trim

* Add as suffix to exit device.
Example: ED5200D x 630 x RHR

Note 1: The following options cannot be ordered together on the same device:

- a) M94 or M97 & D
- b) M94 x M97
- c) M52 x M97
- d) M97 x M107
- e) M61 or M92 & D
- f) M61 x M92
- g) M61x M52
- h) M52 & D
- i) ED5600 x M91 & M93
- j) ED5600 SAF or SEC x M91 or M93
- k) Surface vertical rod exit devices with M61 x M91, M92 or M93.
- l) M94 or M97 x W024

Note 2: When ordering a surface vertical rod exit device with the D option, rod and latch guards (provided by other) must be used.

Note 3: M88 (NFPA30) M89 (BOCA-15) and M90 (BOCA-30) are available only as options for suffix "D" Delayed Egress Exit Devices. See page 36 for details.

Electrified Exit Devices

ED5000

Electric Latch Pullback - M94

Continuous-duty solenoid retracts the latch bolt(s) for momentary or maintained periods of time. Latch Pullback provides a remote means of unlocking exit devices.

Application

SecureBolt® Exit Devices

Rim Exit Devices

Surface Vertical Rod Exit Devices

Concealed Vertical Rod Exit Devices

Mortise Exit Devices

Listings

UL listed for both Panic and Fire Exit Hardware.

Electrical Specifications

Requires 782 Controller (120VAC input, output sequencer for one or two devices). No substitutes; using other power sources voids warranty. Requires a 4-wire electrical transfer pivot or hinge. See page 43 for controller information.

Solenoid

A dual retraction/holder-type solenoid.

6-9 Amp in rush @ 24VDC to 28VDC (.25 Amp holding-continuous duty.)

Device bolts remain retracted for as long as the device is energized. Removal of power returns the device to the life safety, self-latching mechanical mode.

Interface with central or local fire alarm system, automatic door operators, access control systems, security alarm systems, and blow open door systems.

Note: This feature is not available with Electric Dogging (M97) or delayed egress (D) on the same device.

How to Order

Specify Quick Code M94.

Electric Dogging - M97

This electronic feature will provide continuous dogging when power is applied and the push bar is depressed manually. Interruption or removal of the power will release the pushbar and return the exit device back to normal operation.

Application

SecureBolt® Exit Devices

Rim Exit Devices

Surface Vertical Rod Exit Devices

Concealed Vertical Rod Exit Devices

Mortise Exit Devices

Listings

UL listed for both Panic and Fire Exit Hardware.

Electrical Specifications

.35 Amps @ 24VDC continuous duty
(2) 36 volt holding magnets holding force (86 lbf. total)

Note: This feature is not available with Electric Latch Pullback (M94) or delayed egress (D) on the same device.

How to Order

Specify Quick Code M97.

Mortise Device Trim Control

Safe or Secure

Mortise device trim control provides a remote means of locking and unlocking the outside lever trim. This feature is provided by continuous duty solenoids in the device mortise lock.

Application

Mortise exit devices with lever trim.

Listings

UL listed for both Panic and Fire Exit Hardware.

Electrical Specifications

24VDC 330 milliamperes

Fail Safe units maintain the door locked as long as the device is energized.

Fail Secure units maintain the door unlocked as long as the device is energized.

Regulated 24VDC power supply required.

Note: SAF & SEC options are only available with ED5600L and ED5600(A)L version lock body functions and may not be combined with either the M91 or M93 monitoring options.

How to Order

Specify Quick Code "SAF" for Safe or "SEC" for Secure.

Electrified Exit Devices

ED5000

Delayed Egress Exit Device

The delayed egress option provides additional security and safety in a strong line of exit hardware. The delayed egress exit device is an electromechanical device used to secure interior or exterior openings.

Operation

The exit door is normally closed and latched. The Delayed Egress Exit Device "D" secures the door in the locked mode with the solid Red LED indicating locked mode status. Depressing the pushpad for less than 3 seconds will sound the nuisance beep without initiating the alarm. Depressing the pushpad for 3 seconds or longer will initiate an irreversible local audible beeping tone and a visual amber indicator until the device releases. The person depressing the exit bar is denied egress for 15 or 30 seconds and security personnel are alerted. After the delay time of 15 or 30 seconds the device releases, the LED changes to Green, and the alarm changes to a steady tone which continues to alarm until manually reset by key. The remote monitoring contact outputs can be used to alert security personnel.

Note: The 15-second time delay is standard. 30-second time delay is optional (may be accepted by local jurisdiction).

Applications

- For use on hollow metal, wood or composite interior or exterior doors.
- Available for rim, SecureBolt®, surface vertical rod, concealed vertical rod and mortise panic and fire-rated exit devices. For surface vertical rod exit devices, rod and latch guards (provided by other) must be used.
- Complies with NFPA 101 "Code For Safety To Life From Buildings And Structures" by National Fire Protection Association.
- BOCA options available to comply with National Building Code requirements. BOCA option is not suitable for installations in accordance with NFPA 101.



- 1-3/4" (45mm) door thickness standard; 2" (51mm) and 2-1/4" (57mm) optional; specify D200 or D214 when ordering.
- Standard 36" device fits 36" doors only. Device cannot be cut less than 36".
- Option W048 fits doors 42" – 48". Devices cannot be cut less than 42".

Listing

- UL/cUL Listed
 - Fire Exit Hardware (GXHX/GXHX7)
 - Controlled Exit Panic Device (FUKD/FUKD7)
 - Special Locking Arrangements (FWAX/FWAX7)
- BHMA (ANSI A156.3 and ANSI A156.24) Directory of Certified Exit Devices

Specifications

Input Voltage: 24VDC (+/- 10%) Regulated and filtered.

Power Consumption

- Standard Device: 500 mA
- Device with Electric Trim Control: 1.5 Amp
- Mortise Device with "Safe" or "Secure" option: 1.5 Amp

Standard Features

Key Switch Operation:

- Normal: The system is armed by applying power to the device (solid Red LED). Depressing the pushpad for more than the nuisance delay time starts the exit delay cycle.
- Bypass: Turning the key switch clockwise to the bypass position allows immediate egress without alarming. The bar functions as a standard exit device. (Red LED flashes slow.)

- Reset/Delay: Used to reset device after the factory set 15 or optional 30 second delay cycle has timed out. If the device is armed, turning the key switch counterclockwise to the reset mode will release the device without alarm for egress and will rearm after 10 seconds. (Red LED flashes quickly.)
- Alarm Strength: 85 Db @ 10'.

Local Visual Status Indicator:

- RED: The exit device is secure and the delayed egress circuitry is energized.
- AMBER: The egress cycle has started, indicated by an irreversible local audible beeping tone.
- GREEN: Exit device is in alarm and has released.

Nuisance Delay Time:

Depressing for 3 seconds or less sounds an audible beep without activating the irreversible alarm sequence. (Immediate alarm can be selected by removing a jumper on the control board.)

Internal Alarm Siren:

When the exit device is armed, depressing the push pad initiates the internal 85db alarm siren.

Remote Control Inputs:

- Remote Reset: Accepts a momentary contact (keyswitch, pushbutton, etc.) to reset the unit during alarm or allows momentary egress (10 seconds) when the unit is armed.
- Remote Bypass: Accepts a momentary contact to put the unit in a maintained bypass operation. The exit device functions as a standard device.

Electrified Exit Devices

ED5000

Alarm Outputs:

Two sets of normally open and normally closed contacts. Contacts change only during alarm status. One set of contacts changes when device delay cycle has started (Alarm). One set of contacts changes when device has released (Secure).

Door Sign:

Door sign per code included.

How to Order

Specify "D" suffix after device.
Example: ED5200SD

Options

Bolt Position Monitor M91:

SPDT (Single Pole Double Throw) switch that monitors the position of the latchbolt or vertical rods. To order, specify M91.

Outside Trim Monitor M93:

Used when outside trim is desired to be used with an external door position switch (by others) input. This switch will allow Bypass (disarms device) when the trim is used for ingress. The device requires setting after entry by means of the keyswitch on the device or a remote switch. To order, specify M93.

Note: If an external DPS is not used, standard trim will allow entry without affecting the device in an armed mode. The device will only be affected when the touchbar is depressed.

Mortise Electric Trim Control SAF/SEC:

The mortise delayed egress exit device can be ordered with Fail Safe or Fail Secure outside trim operation. In a fire condition the Fail Safe trim will release for entry. When access control is used the Fail Secure trim allows entry by means of a remote card reader, keyswitch, pushbutton, etc. To order, specify SAF or SEC.

Note: The trim will open the door without affecting the device in an armed mode if a door position switch (by others) is not used.

30-Second Delay M88:

Device released after 30 seconds. The device will provide visual and audible indication that the delayed egress cycle has been activated. After the device has been released, the siren changes to a steady tone which continues until reset by keyswitch or remote inputs on the device. Required signage must indicate 30 seconds for release. To order, specify M88.

Note: 30 seconds may be accepted by local jurisdiction.

BOCA 15-Second Delay M89:

BOCA 30-Second Delay M90:

Upon pressing the touchpad for 3 seconds or more, the device will sound an audible beeping tone and release for egress after a total of 15 or 30 seconds, sounding the alarm. When the door is re-secured, the device will automatically rearm after 30 seconds. A door position switch (by others) is required for this option. Required signage must indicate 15 or 30 seconds for release. To order, specify M89 for BOCA 15 seconds or M90 for BOCA 30 seconds.

Note: BOCA option is not suitable for installations in accordance with NFPA 101.

Required Accessories

Power Supply:

A regulated and filtered power supply with a Fire Alarm interface is required.

1 Amp minimum @ 24VDC per device.

Special options will require more amperage. Consult factory.

To order, specify:

- BPS-24-1 – 1 Amp @ 24VDC power supply (controls 1 "D" device)
- BPS-24-2 – 1.5 Amp @ 24VDC power supply (controls 2 "D"s or 1 "D" with SAF or SEC options)

Power Transfer:

Allows the power to make the transition from frame to door without pinching or removal of insulation. Optional power transfer: EPTL – concealed transfer for up to and over 120° swing doors. To order specify Part No. 704F28. Consult catalog for additional recommended power supplies and accessories.

Trims

Utilizes heavy-duty and utility trims. See Trims and Functions, pages 20-25 and 30-35.

Cylinders

Utilizes a 1-1/8" mortise cylinder; A02 cam. Cylinder not included unless specified. See Quick Codes, page 53.

Warranty

Exit devices and heavy-duty trim carry a five-year limited warranty. Electronic components carry a two-year limited warranty.



**EPTL
Power Transfer**

Electrified Exit Devices

ED5000

M61 Exit Alarm



Activation

Alarm is armed by turning key clockwise. Low audible chirp indicates alarm has been activated. Alarm will sound when the exit device pushpad is depressed. Factory preset for standard alarm mode which automatically resets after 5 minutes.

Continuous Alarm Mode

Alarm sounds continuously when the exit device pushpad is depressed. Alarm must be manually reset by keyswitch. (This feature is selected by a switch on the circuit board.)

Low Battery Warning

Audible chirp. Every 30 seconds.

Warning Decal

"EMERGENCY EXIT-ALARM WILL SOUND" provided.

Nuisance Alarm

Units are factory preset for instant alarm. Selectable feature for alarm to sound when exit device touchbar is depressed for more than 2 seconds. (This feature is selected by a switch on the circuit board.)

Kit

Available in kit form for field retrofit except surface vertical rods. Order ED50AK.

Arming Delay/Authorized Egress

A 10-second delay (after arming) permits egress (by turning key clockwise).

Alarm Shunt

Ingress shunt alarm input for devices with signal & outside trim monitors (M91 & M93).

Power Requirements

One 9-volt battery (included).

Alarm Strength

90db @ 10 feet.

Arm/Disarm

Requires one 1-1/8" A02 cam mortise cylinder. Clockwise turn arms the alarm, counterclockwise turn disarms or silences the alarm. Low audible chirp indicates alarm has been activated.

Device Status

A Red LED indicator will illuminate every 30 seconds when the alarm is armed.

Tamper Resistant

Built-in safety monitor sounds alarm when tampering occurs.

Cylinders

Mortise 1-1/8" A02 Cam. Cylinder not included unless specified. See Quick Codes, page 53.

Door Width

Available for 36"-48" devices only. Not available with devices less than 36". 48" device can be cut to fit 42"-48" door.

Quick Code

M61

Alarm Kit

ED50AK
ED50AK x W048 (48" devices) optional

Hard Wired Option

A hard wired option is available by using a 9VDC output power supply and a remote power harness. Specify 784 to order the 9VDC output power supply. See page 44 for 784 power supply information. Specify 709F989 to order the remote power harness for a 36" device and specify 709F999 to order the remote power harness for a 48" device.

Exceptions

The ED50AK for the ED5000 series exit devices cannot be retrofitted in the field to the ED5400/5470 series surface vertical rod exit devices.

The alarm option is available for the surface vertical rod devices by factory order only. To order, add the quick code suffix M61 to the device number; for example, ED5470 x M61.

Please note, in accordance with Corbin Russwin's standard limited warranty, any attempt to retrofit the ED50AK to a

surface vertical rod exit device will void the warranties for these products.

Surface vertical rod exit devices with alarm kit cannot be ordered with M91, M92 or M93.

How to Order

Ordering example for Exit Device

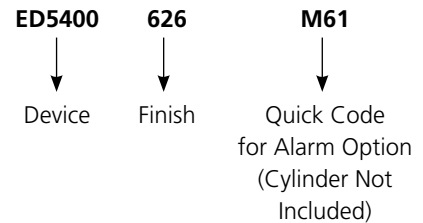

Ordering Example for Alarm Kit Only

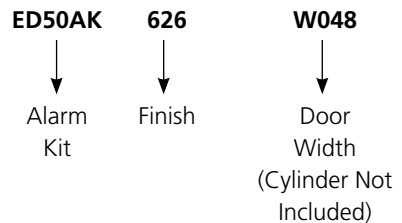

NOTE: Dogging not available with M61 option and ED50AK alarm kit.

Electrified Exit Devices

ED5000

Electrically Controlled Heavy-Duty Trim

Electrically controlled trim provides electric locking and unlocking of the 900 Series heavy-duty lever trim. It easily retrofits into existing applications and is ideal for door control.

Advantages

- Available in Fail Safe or Fail Secure operation
- 24VAC/VDC
- Internal rectifier accepts AC or DC voltage
- Free Wheeling lever when locked
- Key override (specify cylinder)
- Plug connector with 4' wire lead (Exit device can be used as the wire raceway)

Applications

- ED5200(A) Rim
- ED5200S(A) SecureBolt®
- ED5400(A) Surface Vertical Rod
- ED5470(B) Surface Vertical Rod
- ED5800(A) CVR
- ED5860(B) CVR

Trim

Utilizes all 900 series trim lever designs including the Muséo® and Vineyard™ Collections

Electrical Specifications

- Solenoid: 330 mA @ 24 volts continuous duty
- Security Monitor Switch (M98): 4 AMP @ 250VAC

Door Thickness

1-3/4" (44mm) standard.
Optional: 2" (51mm); specify D200.
Optional: 2-1/4" (57mm); specify D214.

Options

- M98 – Security Monitor. A SPDT switch that monitors the position of the solenoid (lock and unlock status).
- M99 – Trim gasket for exterior applications.

Cylinder

Cylinder not included unless specified. See Quick Codes, page 53.

How to Order

N9903 626 RHR M98, 6P

Hardwiring Made Easy®



Electrically Controlled Heavy-Duty Trim

Electrified Exit Devices

ED5000

Functions

Fail Safe

The x9903 trim is locked when power is on and unlocked when power is off.

	Function Description
x9903 (Fail Safe)	<ul style="list-style-type: none"> Lever is locked when power is on (Free Wheeling)
	<ul style="list-style-type: none"> Power off allows entry from trim
	<ul style="list-style-type: none"> Inside device is always active for egress
	<ul style="list-style-type: none"> Mechanical key override (09 Function – Key allows lever to retract latch bolt. Key can only be removed in locked position.)

Fail Secure

The x9905 trim is locked when power is off and unlocked when power is on.

	Function Description
x9905 (Fail Secure)	<ul style="list-style-type: none"> Lever is locked when power is off (Free Wheeling)
	<ul style="list-style-type: none"> Power on allows lever activation for entry
	<ul style="list-style-type: none"> Inside device is always active for egress
	<ul style="list-style-type: none"> Mechanical key override (09 Function – Key allows lever to retract latch bolt. Key can only be removed in locked position.)

x = Lever trim design - Standard, Vineyard™ and Muséo®

Electrified Exit Devices

ED5000

782 Controller

Operation

Designed to control one or two electric latch pullback M94 exit devices. Equipped with two 20-second timers which can operate the exit devices together or independently. Requires a momentary or timed, dry contact input and can be interfaced with access control systems, automatic door operators, "blow open" type scenarios and has provisions for N/C fire alarm systems.

Features

- 2 control inputs. Accepts normally closed dry contacts for device activation from a key switch, push button, access control or fire alarm system.
- 2 normally open control outputs for automatic door operators
- 2 M94 device outputs
- Fire Alarm Interface input
- 24VDC output for audible or LEDs
.25 AMP

Wiring

Up to 40 feet: 16 AWG wire
Up to 60 feet: 14 AWG wire
Up to 100 feet: 12 AWG wire

Electrical Specifications

- 120VAC 60 Hz 750mA (Max)
- 9 Amp inrush for 100 milliseconds

Listings

UL294
UL Class 2 Outputs

Note: The 782 is the only power source to be used with the M94 option. Using any other power supply will void the warranty and cause possible damage to the exit device.

Ordering

782 Controller

EPTL

Concealed power transfer for over 120° swing doors. Installs in door and frame edges. Supports wires up to .25" (6mm) thick, and works with doors hung with butt hinges, continuous hinges and pivots. To order, specify Part No. 704F288.

782 Controller



EPTL

Monitors - M91, M92, M93

Operation

Monitors are used to indicate the authorized and unauthorized use of an opening or to signal and control other opening hardware, such as magnetic locks. Each monitoring device is equipped with one internal single-pole double-throw (SPDT) switch per monitor.

Bolt Position Monitoring - M91

Provides indication of the position of the latch bolt. Used with security systems to monitor the latch bolt; also used to activate automatic door operators upon latch retraction.

Application

See chart on page 36.

Listings

UL listed for both Panic and Fire Exit Hardware.

Electrical Specifications

5 Amps @ 28VDC SPDT contacts

Ordering

Specify Quick Code M91.

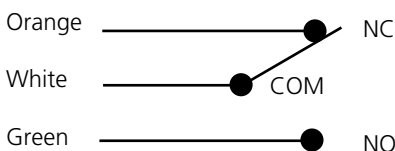

Touchbar Monitoring - M92 Request to Exit - REX

Provides indication of the pushpad being depressed. Used as a request to exit to shunt alarm systems, release electromagnetic locks or monitor egress.

Application

See chart on page 36.

Listings

UL listed for both Panic and Fire Exit Hardware.

Electrical Specifications

4 Amps @ 250 VAC contacts

Ordering

Specify Quick Code M92.

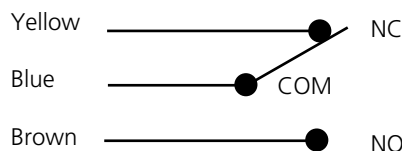

Outside Monitoring or Signaling - M93

Provides indication of the device being operated from the outside. Used as a request to enter signal switch to shunt alarms; also used to monitor entry.

Application

See chart on page 36.

Listings

UL listed for both Panic and Fire Exit Hardware.

Electrical Specifications

5 Amps @ 28VDC SPDT contacts

Ordering

Specify Quick Code M93.

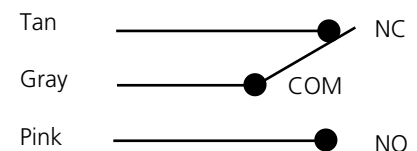

Electrified Options & Accessories

ED5000

BPS Power Supply

Operation

Power supplies are designed to provide reliable filtered and regulated power for long life to a variety of electrified hardware components. Recommended for the SAF, SEC, M97, delayed egress exit devices and electric trim.

Features

- Individual output circuit breakers
- Regulated and filtered fuse protected outputs
- LEDs monitor zone status (voltage or no voltage)
- Slide switches connect or disconnect load from power (Not available on 1 Amp supplies)
- Internal Back-Up battery charging circuit
- Rugged steel enclosure
- Fire alarm interface

Electrical Specifications

- Inputs: 120VAC
- Outputs: 12/24 VDC @ 1 Amp, 2 Amp or 4 Amp, Filtered and regulated outputs

Listings

- UL-cUL CLASS 2
 - Signal Appliances
 - Access Control System Units
 - Special Locking Arrangements - Component
- CE

Applications

- D – Delayed Egress
- M97 – Electric Dogging
- SAF – Fail Safe mortise device trim control
- SEC – Fail Secure mortise device trim control

Note: Batteries are not included with the BPS power supply.

Model	Enclosure	Input	Output
BPS-24-1	12" (304mm) x 9" (229mm) x 4" (102mm)	120VAC	1.0 Amp @ 24 VDC
BPS-24-2	14" (356mm) x 14" (356mm) x 4" (102mm)	120VAC	2.0 Amp @ 24 VDC
BPS-24-4	15" (381mm) x 18" (457mm) x 6" (152mm)	120VAC	4.0 Amp @ 24 VDC
BPS-12-1	12" (304mm) x 9" (229mm) x 4" (102mm)	120VAC	1.0 amp @ 12 VDC
BPS-12-3	14" (356mm) x 14" (356mm) x 4" (102mm)	120VAC	3.0 amp @ 12 VDC

784 Power Supply

Features

- Provides a filtered and regulated 9 VDC remote power
- Requires raceway through the door*
- Optional 12 VDC gel cell battery. Provides continuous operation of in the event of a power failure. To order, specify 793F089.

Includes:

- Plug-In Wall Transformer with approximately 12' (3.6m) of shielded wire that provides input power to the power supply
- Includes 12' (3.6m) of shielded wire for connection between power transfer and power supply
- To order separately, specify 793F039

*Recommended for new opening. Retrofit application may require surface mounted wire mold and transfer loop by others.



Exit Controls and Switches

Key Switches

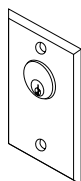

MKA

MKA - (1) SPDT Maintained
 MK - (1) SPDT Momentary
 MKN - (1) SPDT Momentary NS
 MK2 - (1) DPDT Momentary
 MKPZ x MKS - (1) SPDT Momentary with audio Double Gang x Additional Switch
 Note: All key switches come standard with 12/24 VDC bi-color LED.

Specifications

- Keyswitch for operation using a standard 1-1/8" mortise cylinder (A02 cam) (cylinder not included).
- Contact Rating 5 Amps @ 12-24VDC
- SPDT 3-position.

Push Buttons

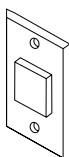

PB2

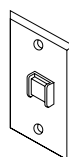

PB3

PB2 - (1) SPDT Momentary
 PB2 - (1) DPST Remote Momentary
 PB3 - (1) DPST Momentary
 PB3A - (1) DPST Maintained (Alt. Action)
 PB3EA - (1) DPST Alternate

Specifications

- 3 Amps @ 12-24 VDC

Audible/Visual Annunciators

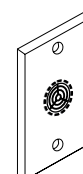

PZ1

PZ1 - Sonalert 90db @ 2ft. 12-24VDC. Mounted on one gang stainless steel plate.

Digital Entry

DK-12 - Digital Keypad - 4 User
 DK-26SS - Digital Keypad NS - 59 User - SS Finish
 DK-26BK - Digital Keypad NS - 59 User - Black Finish

Power Transfers

TSB B-C - Door Cord

Electrified Applications

ED5000

Requirements for Electrical and Data Transfer

To answer the demand for “smart” electronic access control and locking solutions that require fast, easy, and cost-effective installation, ASSA ABLOY Group brands use the ElectroLynx® standardized plug-in connectors and color-coded wiring system.

With *ElectroLynx*, doorway components come pre-wired for easy hookup to the power source. Key to the system is the transfer device hinge that carries power from the frame to the locking hardware.

Features of *ElectroLynx*:

- Makes it easy to bring power to the locking hardware
- Wires have connectors that snap together, like plugging a telephone into a jack

To connect an electrified ED5000 series exit device to the electronic access control system, the following items are required:

- Electrified ED5000 series exit device
- ASSA ABLOY Door Group pre-wired door, or *ElectroLynx* retrofit cable (order from McKinney)
- Electronic transfer device (*ElectroLynx* electronic transfer hinge or Electrical Power Transfer with standard hinge, from McKinney)
- *ElectroLynx* cable from the hinge to above the ceiling (order from McKinney)

Information regarding cable selection, hinge requirements and order strings can be found in the McKinney Transfer Device Solutions catalog. Consult 800-810-WIRE (9473) with questions on application specifications and requirements.

The McKinney QC8 *ElectroLynx* Hinge is recommended for the 9903 function, the 9905 function and all options with the exception of M61 and M93. The McKinney QC12 *ElectroLynx* Hinge is recommended for the M61 and M93 options.

Hardwiring Made Easy®

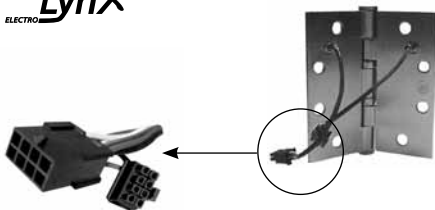

Latch Pullback - M94 Option

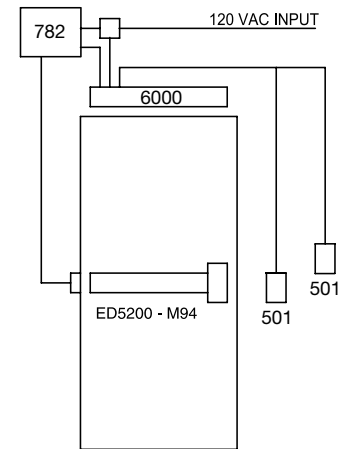

Components

ED5200 x M94 Latch Retraction Exit Device - Corbin Russwin
782 Controller - Corbin Russwin
6000 Operator - Norton
501 Push Pads - Norton
Power Transfer Hinge

Operation

Operation of Push Pads from either side of door will activate the 782 Controller for the Latch Retraction Exit Device. An internal timer on the 6000 will also provide length of time door is open and latch being retracted. Door operator also acts like standard closer when opened manually.

Electrified Applications

ED5000

Electric Dogging & Touchbar Monitoring Switch - M97 & M92

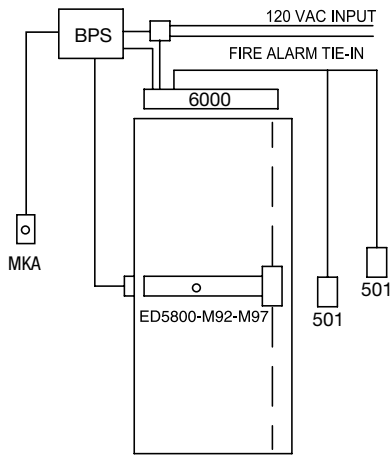

Components

ED5800 x M92 x M97 with Cyl. + Bar Monitor & Elect. Dogging - Corbin Russwin
6000 Operator - Norton
501 Push Pads - Norton
Power Transfer Hinge
BPS Power Supply - Corbin Russwin
Key Switch - Corbin Russwin

Operation

Operation of Electric Dogging combined with the Door Monitor Switch will enable Push Pads for operation of the 6000. A maintained keyswitch will control the activation of the electric dogging which is powered by the Power supply. A Fire Alarm Tie-In, if required, will release the dogging and let the operator work in manual mode when activated. (NOTE: Electric Dogging is not automatic like Latch Retraction. It requires the bar to be pushed in manually the first time after applying power.)

Rim Device with Electric Strike

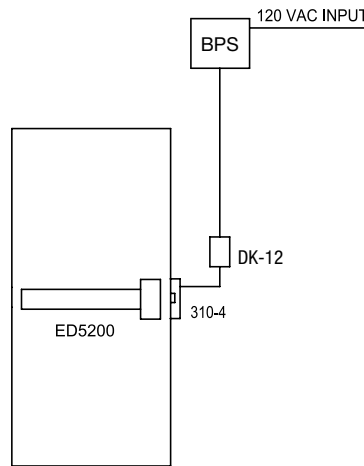

Components

ED5200 Exit Device - Corbin Russwin
Digital Keypad
310-4 Electric Strike
BPS Power Supply - Corbin Russwin

Operation

Operation of DK-12 Digital Keypad will allow keyless entry from the non-protected side of opening. Free exit using the exit device from the protected side of the door.

Latch Pullback - M94 Option with Norton® 6000 Door Operator

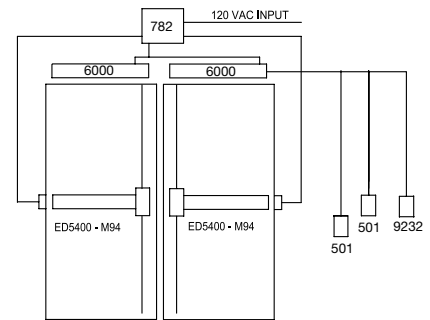

Components

ED5400 x M94 Latch Retraction Exit Device - Corbin Russwin
782 Controller - Corbin Russwin
6000 Operator - Norton
501 Push Pads - Norton
Power Transfer Hinge
Keyswitch - Corbin Russwin

Operation

Activation and operation of Push Pads from either side of door will be controlled by the Maintained Keyswitch. The Push Pads will in turn activate the 782 Controller for the Latch Retraction Exit Device. An internal timer on the 6000 will coordinate and prevent the door from being opened before latch retraction takes place. Standard timers on the 6000 will also provide length of time door is open and latch being retracted. Door operator also acts like standard closer when opened manually.

Electrified Applications

ED5000

Rim Exit Device with Delayed Egress Option on "Exit Only" Door

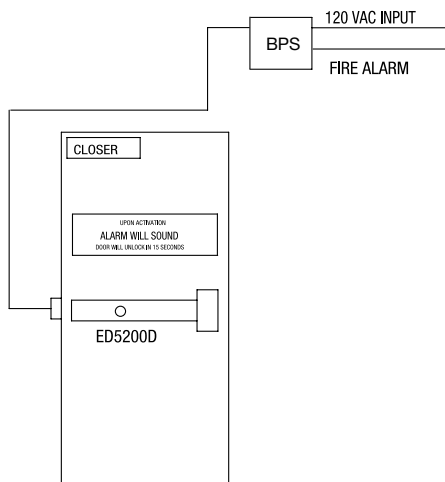

Components

ED5200D - Delayed Egress Exit Device - Corbin Russwin
Power Transfer Hinge
BPS Power Supply - Corbin Russwin
Surface Door Closer - Corbin Russwin

Operation

Operation of the ED5200 D Exit Device will sound an alarm and activate either a 15- or 30-second alarm sequence inside of the exit device. After this time period, the device will release the push bar, making it active, and egress is possible. When the fire alarm is activated, power to the exit device will be interrupted, allowing free egress and mechanical latching. Authorized alarm bypass and reset is done through the built-in keyswitch located in the exit device.

Rim Exit Device - High-Security Application M91, M92 and M93 Monitoring Switch Options With Door Position Switch

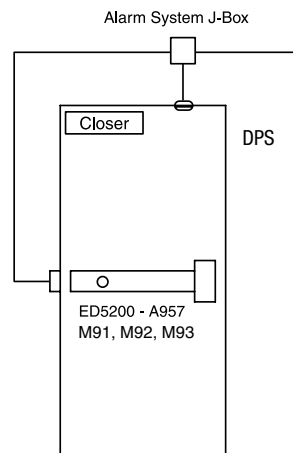

Components

ED5200 - A957 Nightlatch Trim - Corbin Russwin
M91 Bolt Monitor Switch
M92 Touchbar Monitor Switch
M93 Trim Monitor Switch
Door Position Switch
Power Transfer Hinge
Surface Door Closer - Corbin Russwin

Operation

Operation of the ED5200 Exit Device with the M91, M92, M93 and a door position switch can be used together or individually to sound an alarm, shunt an alarm, monitor the door's security or as a "Request to Exit" in conjunction with a magnetic lock.

Electric Trim

Rim Exit Device with Electrified Trim

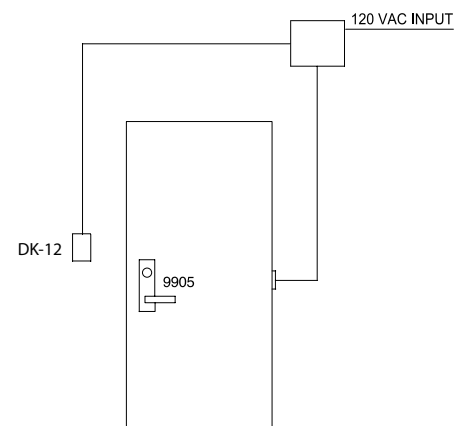

Components

9905 Electrified Trim - Corbin Russwin
ED5200 Rim Exit Device - Corbin Russwin
DK-12 Digital Keypad by Corbin Russwin
Electrified Hinge
BPS-24-1 Power Supply - Corbin Russwin

Operation

Operation of the 917 Digital Keypad will allow keyless entry from the non-protected side of the opening. When a valid code is entered into the keypad, voltage will be applied to the trim, making the lever active and allowing ingress. Free exit is allowed by using the exit device from the protected side of the door.

Mullions and Surface Bolt Kit

ED5000



Mullions

Used to install two Rim Exit Devices in a double door opening. May be quickly and easily removed when a full double door opening is temporarily required.

Materials and Finish

Steel mullions, 2" x 3" with malleable iron top and bottom retainers; furnished with zinc-plated fasteners for metal frames and concrete floors. May be cut, drilled and tapped in the field for Rim Exit Devices. Mullion and Mullion retainers are prime coat red paint.

Options

Spacer Block

Recommended for double rabbeted frames where the stop face width is less than the mounting hole spacing and also for door frames 5-3/4" (176mm) or less. To order with a mullion, specify M95. To order separately, specify Part No 744F328.

Angle Bracket

Recommended for any header configuration with less than 3" (76mm) of mounting surface. To order with a mullion, specify M96. To order separately, specify Part No 744F338.

Mullion Stabilizer Kit

Controls the movement of the mullion. Recommended for openings over 7' high, or whenever door movement must be minimized. To order with mullion, specify M57. To order separately, specify Part No. 653F11-1 x 628 (aluminum).

Surface Bolt Kit

Designed for severe windload (Hurricane Code) environments where surface bolts are required (e.g., on inactive doors). To order separately, specify Part No 988CR.



How to Order

Removable Mullions

Door Height	Description	Specify Quick Code
Up to 7'0"	Steel Mullion - Panic Rated	907
Up to 8'0"	Steel Mullion - Panic Rated	908
Up to 10'0" (ED5200, ED5200S only)	Steel Mullion - Panic Rated	910
Up to 7'0"	Steel Mullion - 3 Hour Fire Rated	907A
Up to 8'0"	Steel Mullion - 3 Hour Fire Rated	908A
Up to 7'0"	Steel Mullion - 3 Hour Fire Rated, Windstorm Certified	FE707A ¹
Up to 8'0"	Steel Mullion - 3 Hour Fire Rated, Windstorm Certified	FE708A ¹

Key Removable Mullions

Door Height	Description	Specify Quick Code
Up to 7'0"	Steel Mullion - 1-1/2 Hour Fire Rated	907BKM ²
Up to 8'0"	Steel Mullion - 1-1/2 Hour Fire Rated	908BKM ²
Up to 10'0" (ED5200, ED5200S only)	Steel Mullion - Panic Rated	910KM ²
Up to 7'0"	Steel Mullion - 3 Hour Fire Rated, Windstorm Certified	WS707AKM ²
Up to 8'0"	Steel Mullion - 3 Hour Fire Rated, Windstorm Certified	WS708AKM ²

Notes:

- For use with UL listed door assemblies that comply to FEMA 361 and FEMA 320 guidelines. For the latest listings on compliant door assemblies visit our website at corbinrusswin.com
- Cylinder and collars not included, specify separately. See page 53.

Parts - Key Removable Mullion

Top Retainer and Screw Packet and Bottom Retainer and Screw Packet

Mullion Series	Top Retainer and Screw Packet	Bottom Retainer and Screw Packet	Locking Mechanism Packet
907BKM 908BKM 910KM	713F948	713F988	744F258
WS707AKM WS708AKM	713F958	713F908	744F208

Parts - Removable Mullion

Top Retainer and Screw Packet and Bottom Retainer and Screw Packet

Mullion Series	Top Retainer and Screw Packet	Bottom Retainer and Screw Packet
907 908 910 907A 908A	713F518	713F528
FE707A FE708A	713F938	713F998

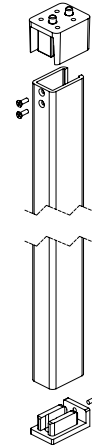

Options & Accessories

ED5000

Shim Kits

Designed for mounting an exit device over raised vision light molding. Each kit contains two sets of 1/8" thick shims to shim a device 1/8" (3mm) or 1/4" (6mm). Black finish. To order with exit device, specify M58. To order separately, specify Part No.

Exit Device Type	Shim Kit Part No.
ED5200 (A)	697F33-8
ED5200S(A)	
ED5600 (A)	
ED5800 (A)	
ED5860(B)	
ED5400 (A)	697F34-8
ED5470(B)	

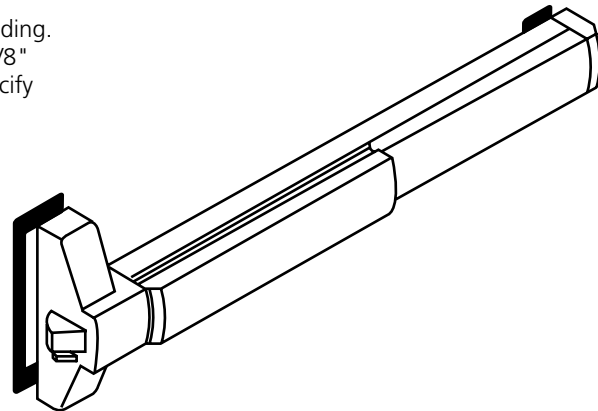

Cylinder Dogging

To order Cylinder Dogging with exit device, specify M52. Cylinder not included unless specified. Cylinder dogging not available for fire-rated devices. See Quick Codes, page 53.

Cylinder Dogging Kit

Designed to convert a panic device from hex key dogging to cylinder dogging. To order Cylinder Dogging Kit, specify Part Number x Finish below. Cylinder not included.

Surface and Concealed Vertical Rod Extension Kits

Used to extend the height of standard length rods supplied with vertical rod exit devices. Available in 2", 6" and 12" sizes. To order with exit device, see Quick Codes, page 53. To order separately, specify Part No. x Finish.

Rod Extension	Rod Extension Kit Part No.
2" (50mm)	655F15 x Finish
6" (152mm)	655F16 x Finish
12" (305mm)	655F17 x Finish
24" (610mm)	684F42 x Finish

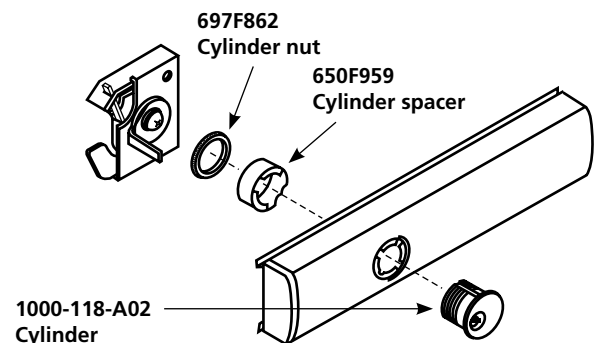

Bar Length	Cylinder Dogging Kit Part No.
Standard (W036)	653F12 x Finish
W048	653F14 x Finish

Note: Cylinder dogging not available for fire-rated devices.

ED5000DB Inactive Bar

Non-operating dummy pushpad available for doors up to 48" wide. May be field cut for narrower doors. To order, specify ED5000DB x Finish.

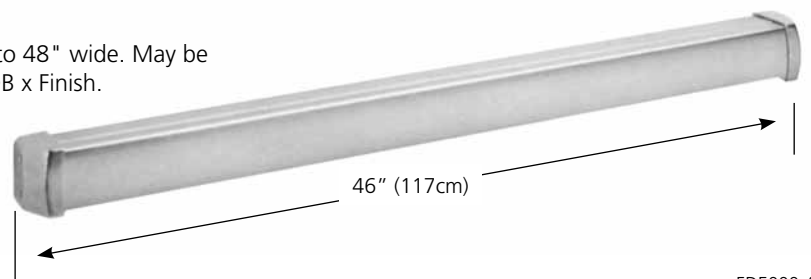

Options & Accessories

ED5000

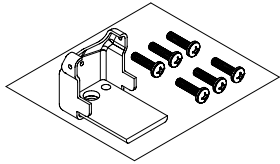

End Cap Reinforcement**

A solid steel plate, welded to the end bracket, evenly distributes impact forces over a larger surface area, eliminating point loading. To order with an exit device, specify M109. To order separately specify 705F09 x finish.

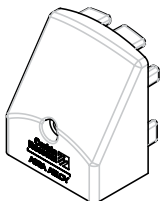

Flush End Cap

Durable heavy-duty cast steel or stainless steel, sits flush on the exit device rail and has a low profile which eliminates catch points. To order with a device, specify M110. To order separately specify 710F00M x finish.

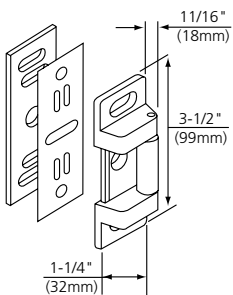

SecureBolt® and Fire-Rated Rim Strike and Rim Strike

ED5200S, ED5200SA and ED5200A devices. Supplied with locking plate and two 1/16" (1.6mm) shims. For doors with 1/2" (13mm) or 5/8" (16mm) stop. Adjustable to compensate for shrinkage and swelling of door. 3-1/2" x 1-1/4" (89mm x 32mm). Black finish only. To order separately specify 650F30-8 ED5200(A) or 730F77-8 ED5200S(A).

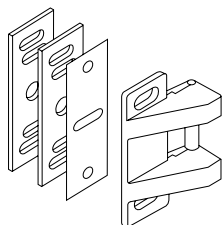

Rim x Vertical Rod Strike

Required for ED5200 and ED5200S devices when used on pair of doors with vertical rod devices. Black finish only. To order with device, specify S02. To order separately, specify 655F71-8.

Surface and Concealed Vertical Rod Strikes

(Screws Included)

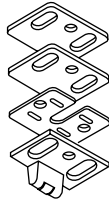

Top Strike

Standard on ED5400(A) and ED5800(A) devices. Supplied with two 1/16" (1.6mm) shims and one 1/16" (1.6mm) locking plate. Adjustable to compensate for shrinkage and swelling of door. 1-9/16" x 15/16" (40mm x 24mm). Black finish only. To order separately, specify 650F54-8.



Bottom Strike

Standard on ED5400(A) and ED5800(A) devices. 1-1/16" (27mm) diameter x 1/16" (1.6mm) lip x 11/16" (17mm) high. Black finish only.

Both top and bottom strikes are included in the vertical rod parts packet. To order parts packet, specify 650F57-8.

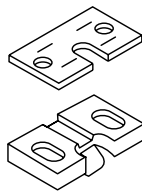

Top Strike

Standard for ED5470 and ED5470B devices. Supplied with one 1/16" (27mm) shim. Adjustable to compensate for shrinkage and swelling of door. 2" x 1" (51mm x 25mm). Black finish only. Top strike is included in SVR parts packet. To order parts packet, specify 654F158 (M55) or 697F978. To order strike separately, specify 681F70-8.

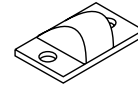

Top Strike

Standard for ED5860 and ED5860B devices. Recessed strike. 2" x 1-5/8" (51mm x 41mm). Black finish only. Top strike is included in CVR parts packet. To order parts packet, specify 698F058 or 698F048 (M55). To order separately, specify 681F77-8.

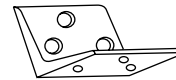

Flush Transom Top Strike Bracket

Optional for use with ED5400 and ED5400A devices. Used to mount top strike on openings with flush transom. 2-1/2" x 1-5/8" (64mm x 41mm). Black finish only. To order with exit device, specify M67. To order separately, specify 650F87-8.

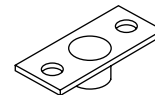

Bottom Strike for 1/2" Thresholds

Recommended for use with vertical rod devices. Required in fire-rated openings with 1/2" (13mm) threshold or for flush mount. 2-5/8" x 1-1/16" (67mm x 27mm). Black finish only. To order with exit device, specify S09. To order separately, specify 650F88-8.

**Note: Six 1/4 x 20 screws come standard with either M109 option or 705F09 kit. Only two screws required to fasten end cap assembly to door for retrofit. Other four screws are used with SecureBolt® Latch Head if ordered as an M109 option with complete device. When the kit is ordered a new end cap is also supplied.

Options & Accessories

ED5000

Mortise Strikes

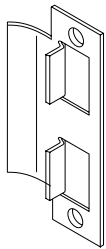

Mortise Strike
Standard on ED5600 and ED5600A. Non-handed, ANSI curved lip, 4-7/8" x 1-1/4" x 1-1/4" (124mm x 32mm x 32mm) lip to center. Black finish. To order separately, specify 650L657020.

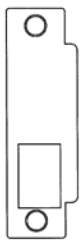

Mortise Strike for Pairs of Doors with Astragal
Optional for use with ED5600 and ED5600A devices where an astragal is to be installed. Non-handed, ANSI straight lip, 4-7/8" x 1-1/4" x 7/8" (124mm x 32mm x 22mm) lip to center. Black finish. To order with exit device, specify SS078. To order separately, specify 653L157014.

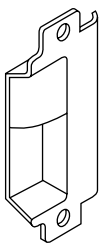

Open Back Strike
Optional for use with ED5600 x vertical rod devices on a pair of doors. Non-handed, 4-7/8" x 1-1/4" (124mm x 32mm). Black finish. To order with exit device, specify SB134 for 1-3/4" doors, SB214 for 2-1/4" doors. To order separately, specify Part No.

Door Thickness	Type	Part No.
1-3/4" (44mm)	Curved lip	653L183016
	Straight lip	653L163016
2-1/4" (57mm)	Curved lip	653L183020
	Straight lip	653L163020

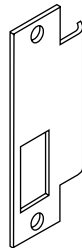

Mortise Strike
Standard on ED5600 and ED5600A devices on 2" (51mm) (D200) and 2-1/4" (57mm) (D214) thick doors. Handed ANSI curved lip, 4-7/8" x 1-1/4" x 1-1/2" (124mm x 32mm x 38mm) lip to center. Black finish. To order separately, specify 656L677024 for LHR doors, 656L687024 for RHR doors.



ANSI Wrought Strike Box
Optional for use with ED5600 and ED5600A devices. To order with exit device, specify M17. To order separately, specify 120F76-8.

Filler Plates



Optional for use on stock metal doors when required. To order, specify 334F99-8 600.

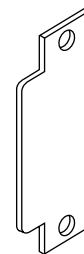

Optional for use on stock metal doors when required. To order, specify 236L708018 x Fin.

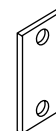

Optional for use on stock metal doors when required. To order, specify 077F19-8 600.

Facts & Figures

ED5000

ED5000 Series (all variables)

Series	"A"	"B"
ED5000 ED5000A	32-7/8" (835mm)	18" (457mm)
ED5000 x W048 ED5000A x W048	44-7/8" (1140mm)	24" (610mm)
ED5000 x W024 ED5000A x W024	20-7/8" (530mm)	12" (305mm)

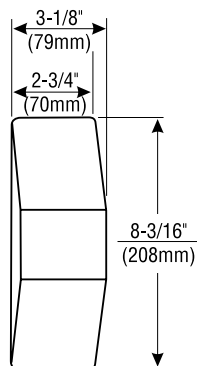

Cover Detail

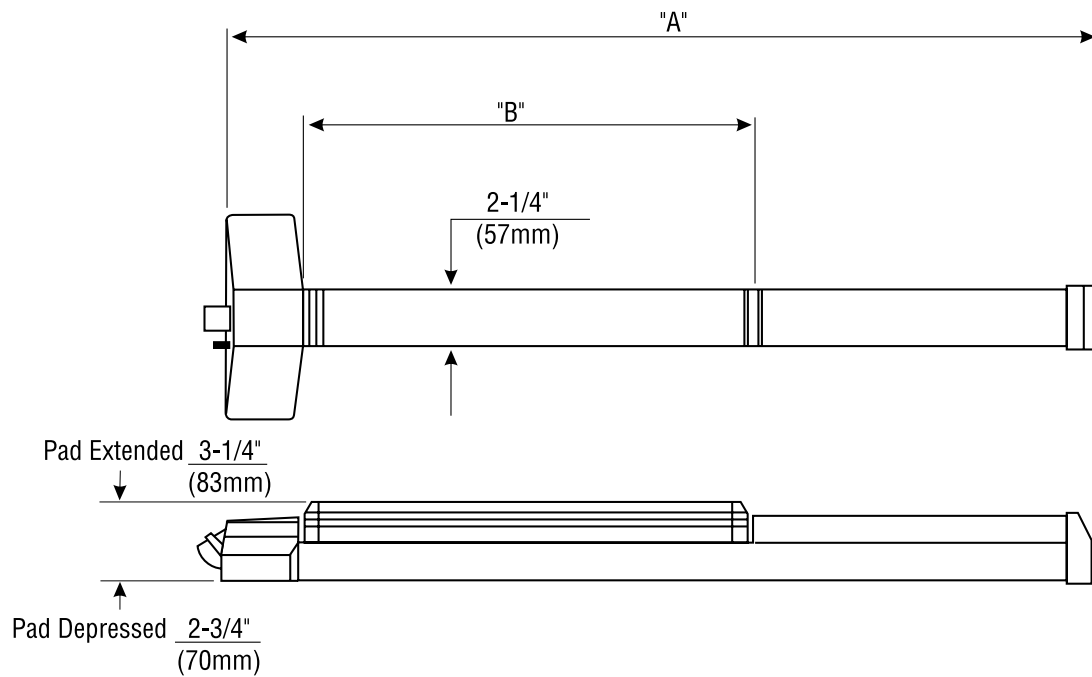

700 Series KRM* & Cylinder Dogging

Mortise cylinders

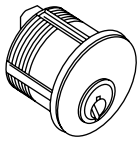

Description	Part Number	Cylinder Dogging Collars	Key Removable Mullions*	
			Part Number	Cylinder Collar
6-pin	1000-118-A02	N/A	1000-118-A02	None Required
7-pin	1000-114-A02-7	270F15	1000-114-A02-7	None Required
6-pin, IC	1080-114-A02	270F15	1080-114-A02	None Required
7-pin, IC	1080-112-A02-7	654F07	1080-112-A02-7	447F42
6-pin, IC, less core	1070-114-A02	270F07	1070-114-A02	None Required
7-pin, IC, less core	1070-112-A02-7	654F07	1070-112-A02-7	447F42
6-pin, Security	1010-118-A02	N/A	1010-118-A02	None Required
6-pin, Security IC	1090-114-A02	270F15	1090-114-A02	None Required
7-pin, Pyramid Security	1027-114-A02	270F15	1027-114-A02	None Required
7-pin, Pyramid Security IC	1037-114-A02	270F15	1037-114-A02	None Required
7-pin, Pyramid High Security	1020-114-A02	270F15	1020-114-A02	None Required
7-pin, Pyramid IC High Security	1030-114-A02	270F15	1030-114-A02	None Required

*The 700 series key removable mullion was discontinued on January 1, 2010. The cylinders and cylinder rings are listed for reference only.

900 Series Trim

Rim cylinders

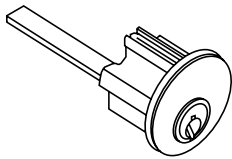

Description	Part Number	Cylinder Collar	57 Function Part Number	Cylinder Collar**
6-pin	3000-058	None Required	3000-200N*	None Required
7-pin	3000-058-7	422F88	3000-200-7	422F88
6-pin, IC	3080-058	422F88	3080-178	422F88
7-pin, IC	3080-058-7	686F98	3080-178-7	686F98
6-pin, IC, less core	3070-058	422F88	3070-178	422F88
7-pin, IC, less core	3070-058-7	686F98	3070-178-7	686F98
6-pin, Security	3010-058	None Required	3010-200	422F88
6-pin, Security IC	3090-058	422F88	3090-178	422F88
7-pin, Pyramid	3020-058	422F88	3020-200N	422F88
7-pin, Pyramid IC	3030-058	422F88	3030-178	422F88
7-pin, Pyramid Security	3027-058	422F88	3027-200N	422F88
7-pin, Pyramid Security	3037-058	422F88	3037-178	422F88

*For K157, substitute -200

**K157 uses the 270F15 cylinder ring

900 Series KRM

Mortise cylinders

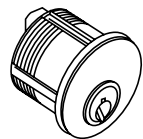

900 Series KRM
Mortise cylinders

Description	Part Number	Quick Code	900 Series Cylinder Collar			WS700 Series Cylinder Collar		
			1-1/8"	1-1/4" or 1-1/4" IC	1-1/2" IC	1-1/8"	1-1/4" or 1-1/4" IC	1-1/2" IC
6-Pin	1000-118-A62	6P						
7-Pin	1000-114-A62-7	7P						
6-Pin, IC	1080-114-A62	C6						
7-Pin, IC	1080-112-A62-7	C7						
7-pin, Pyramid High Security	1020-114-A62	PHS						
7-pin, Pyramid Security	1027-114-A62	PS						
7-pin, Pyramid High Security IC	1030-114-A62	PCHS	610F01*	447F43*	609F37*	447F42*	610F01*	609F36*
7-pin, Pyramid Security IC	1037-114-A62	PCS						
Security	1010-118-A62	HS						
Security IC	1090-114-A62	CHS						
6-pin, IC, less core	1070-114-A62	CL6						
7-pin, IC, less core	1070-112-A62-7	CL7						

*Specify Finish

900 Series Mortise Trim

Mortise cylinders

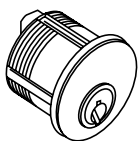

Description	Part Number	Cylinder Collar
6-pin	1000-112-A02	None Required
7-pin	1000-112-A02-7	None Required
6-pin, IC	1080-112-A02	None Required
7-pin, IC	1080-112-A02-7	None Required
6-pin, IC, less core	1070-112-A02	None Required
7-pin, IC, less core	1070-112-A02-7	None Required
6-pin, Security	1010-112-A02	None Required
6-pin, Security IC	1090-112-A02	None Required
7-pin, Pyramid High Security	1020-112-A02	None Required
7-pin, Pyramid IC High Security	1030-112-A02	None Required
7-pin, Pyramid Security	1027-112-A02	None Required
7-pin, Pyramid Security IC	1037-112-A02	None Required

Cylinders

ED5000

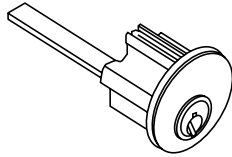

Inside Cylinder For ED5602 Double Cylinder Exit Device

Rim cylinders

ED5602 Double Cylinder Exit Device
Rim cylinders

Description	Part Number	Cylinder Collar
6-pin	3000-200	270F15
7-pin	3000-200-7	654F07
6-pin, IC	3080-178	654F07
7-pin, IC	3080-178-7	654F08
6-pin, IC, less core	3070-178	654F07
7-pin, IC, less core	3070-178-7	654F08
6-pin, Security	3010-200	654F07
6-pin, Security IC	3090-178	654F07
7-pin, Pyramid	3020-200	654F07
7-pin, Pyramid IC	3030-178	654F07
7-pin, Pyramid Security	3027-200	654F07
7-pin, Pyramid Security	3037-178	654F07

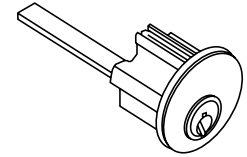

ED5202 Double Cylinder Exit Device

Rim cylinders

ED5202 Double Cylinder Exit Device
Rim cylinders

Description	Part Number	Cylinder Collar
6-pin	3000-138	270F15
7-pin	3000-138-7	654F07
6-pin, IC	3080-114	654F07
7-pin, IC	3080-114-7	654F08
6-pin, IC, less core	3070-114	654F07
7-pin, IC, less core	3070-114-7	654F08
6-pin, Security	3010-138	654F07
6-pin, Security IC	3090-114	654F07
7-pin, Pyramid	3020-138	654F07
7-pin, Pyramid IC	3030-114	654F07
7-pin, Pyramid Security	3027-138	654F07
7-pin, Pyramid Security	3037-114	654F07

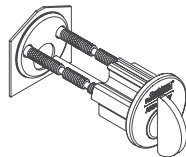

Rim Thumbturn

Description	Part Number
Rim Thumbturn - 1-3/8"	3300 -138
Rim Thumbturn - 1-3/8" - Ergonomic	3300-138-M34
Rim Thumbturn - 2"	3300-200
Rim Thumbturn - 2" - Ergonomic	3300-200-M34

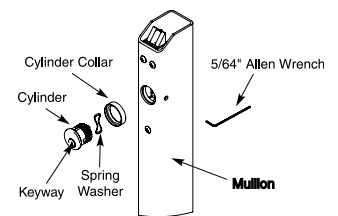

900 Series KRM Cylinder Collar Packet

Mullion Series	Cylinder Length and Type			
	1-1/8"	1-1/4"	1-1/4" IC	1-1/2" IC
WS707AKM WS708AKM	447F42*		610F01*	609F36*
907BKM 908BKM 910KM	610F01*		447F43*	609F37*

Note: Cylinder collar packets contain a collar and spring washer.
*Specify finish when ordering packets.

Cylinder and Keying

Description	Specify
Less cylinder(s)	(standard)
Conventional 6-pin	6P
Conventional 7-pin	7P
Security	HS
Security interchangeable core (IC)	CHS
IC 6-pin	C6
IC 6-pin with temporary construction core (Red)	CT6R
IC 6-pin with temporary construction core (Blue)	CT6B
IC 6-pin with temporary construction core (Green)	CT6G
IC 6-pin with temporary construction core	CT6
IC 6-Pin with temporary disposable core	CT6D
IC 6-pin less core	CL6
SFIC 6-pin with less core	CLS6
SFIC 6-pin with SFIC disposable temporary core	CT6SD
IC 7-pin (rim only)	C7
IC 7-pin with temporary construction core (Red)	CT7R
IC 7-pin with temporary construction core (Blue)	CT7B
IC 7-pin with temporary construction core (Green)	CT7G
IC 7-pin with temporary construction core	CT7
IC 7-Pin with temporary disposable core	CT7D
IC 7-pin less core (rim only)	CL7
SFIC 7-pin with less core	CLS7
SFIC 7-pin with SFIC disposable temporary core ₃	CT7SD
Pyramid Security fixed core	PS
Pyramid Security IC	PCS
Pyramid Fixed Core	PHS
Pyramid IC	PCHS
Pyramid with temporary construction core	CTP
Pyramid less core	CLP
Blockout function	BO
0-bitted with 2 blank keys	(standard)
Keyed random	KR
Construction master keyed	CMK

Cylinder and Keying (cont)

Description	Specify
Visual key control (VKC)	
No keying data stamped on key or cylinder	VKC0
Keys only	VKC1
Cylinders and keys (not for HS or CHS)	VKC2
Cylinders only (not for HS or CHS)	VKC3
Concealed key control (CKC)	
CKC cylinders with VKC keys	CKC2
CKC cylinders only	CKC3
2 keys per cylinder	(standard with cylinder)
Other than 2 keys	KY# (e.g., KY6)

Strikes

Description	Specify
Rim x vertical rod on pairs of doors	S02
Surface and concealed vertical rod Bottom strike for 1/2" thresholds or flush mount	S09
Mortise ANSI strike for pairs of doors with astragal	SS078
Open back strike for 1-3/4" doors	SB134
Open back strike for 2-1/4" doors	SB214

Door Height

Door Height	Specify
ED5400(A) and ED5470(B) devices	
7'0"	(standard)
7'2"	H0702
7'6"	H0706
8'0"	H0800
ED5800(A) devices	
8'0"	(standard)
ED5470(B), ED5860(B) devices only	
9'0"	H0900
10'0"	H1000

Door Width

Door Width	Specify
24" (610mm)	W024
36" (914mm)	(standard)
48" (1219mm)	W048



Quick Codes

ED5000

Door Thickness

Door	Specify
1-3/4" (44mm)	(standard)
2" (51mm)	D200
2-1/4" (57mm)	D214

Finish

Description		Specify
US3	Bright Brass	605
US4	Satin Brass	606
US9	Bright Bronze	611
US10	Satin Bronze	612
US10B	Dark Oxidized Satin Bronze, oil rubbed	613
10BE	Dark Oxidized Satin Bronze Equivalent	613E
US14	Bright Nickel Plated	618
US15	Satin Nickel Plated	619
US26	Bright Chromium Plated	625
US26D	Satin Chromium Plated	626* (Trim only)
	Satin Chromium Plated with MicroShield® 	626C
US32	Bright Stainless Steel	629
US32D	Stain Stainless Steel	630
	Stain Stainless Steel with MicroShield® 	630C
—	Black oxidized bronze, oil rubbed	722

*Contact factory for devices required in BHMA 626

Handing

Hand	Specify
Right Hand Reverse	RHR
Left Hand Reverse	LHR

Miscellaneous Options

Description	Specify
Torx® head screws	M04
ANSI wrought strike box (mortise)	M17
Knurling outside and inside (embossed touchbar - device side) ¹	M20
Knurling outside only (trim side) ¹	M21
Knurling inside only (embossed touchbar - device side)	M22
Abrasive coat outside and inside (trim and device)	M23
Abrasive coat inside only (device side)	M24
Abrasive coat outside only (trim side)	M25
24", 36" and 48" PathLite™ Photoluminescent Touchbar Cover	M49
Less dogging	M51
Cylinder dogging	M52
Sex nuts and bolts (SNBs)	M54
Less bottom vertical rod (ED5470(B)/ED5860(B) Only)	M55
Narrow Stile Cover	M56
Mullion stabilizer	M57
Shim kit (for vision light)	M58
Parabolic escutcheon	M60
Wood screws for use on fire-rated solid wood or wood core doors	M64
Flush transom top strike bracket (ED5400 and ED5400A only)	M67
Door frame filler block for double rabbeted frames	M95
Door frame angle bracket for aluminum frames	M96
Windstorm Certified products for ED5200S(A) and ED5470(B) Only ^{2, 3, 4, 5}	M107
High Impact End Clamp	M109
Flush End Cap	M110

Notes:

1. Not available with VT9, VTL9, VT9M and VTL9M trim.
2. ED5200S(A) x M107 requires through bolts.
3. ED5470(B) maximum opening height is 8'0".
4. Contact Ceco, Curries® or Fleming for detailed frame/door requirements and limitations.
5. Not available with electric dogging (M97).

Key Removable Mullions

Description	Specify
Up to 7'0" Steel Mullion - 1-1/2 Hour Fire Rated	907BKM ¹
Up to 8'0" Steel Mullion - 1-1/2 Hour Fire Rated	908BKM ¹
Up to 10'0" (ED5200, ED5200S only) Steel Mullion - Panic Rated	910KM ¹
Up to 7'0" Steel Mullion - 3 Hour Fire Rated, Windstorm Certified	WS707AKM ¹
Up to 8'0" Steel Mullion - 3 Hour Fire Rated, Windstorm Certified	WS708AKM ¹

Note:

1. For use with UL listed door assemblies that comply to FEMA 361 and FEMA 320 guidelines. For the latest listings on compliant door assemblies visit our website at corbinrusswin.com

Removable Mullions

Description	Specify
Up to 7'0" Steel Mullion - Panic Rated	907
Up to 8'0" Steel Mullion - Panic Rated	908
Up to 10'0" (ED5200, ED5200S only) Steel Mullion - Panic Rated	910
Up to 7'0" Steel Mullion - 3 Hour Fire Rated	907A
Up to 8'0" Steel Mullion - 3 Hour Fire Rated	908A
Up to 7'0" Steel Mullion - 3 Hour Fire Rated, Windstorm Certified	FE707A ¹
Up to 8'0" Steel Mullion - 3 Hour Fire Rated, Windstorm Certified	FE708A ¹

Note:

1. Cylinder and collars not included, specify separately. See page 53.

Electrified Options for Exit Devices

Description	Specify
Exit Alarm Device (cylinder not included)	M61
Bolt Position Monitoring	M91
Request to Exit/Touchbar Monitoring or Signaling	M92
Outside Trim Monitoring or Signaling	M93
Electric Latch Pullback	M94
Electric Dogging	M97
Mortise Device Lock with Outside Trim Control (Fail Safe)	SAF*
Mortise Device Lock with Outside Trim Control (Fail Secure)	SEC*
Delayed Egress (15 second delay standard)	D
30 second delay (may be accepted by local jurisdiction) (with "D" option only)	M88
BOCA 15-second delay (with "D" option only)	M89
BOCA 30-second delay (with "D" option only)	M90
Security Monitor	M98 [^]
Trim Gasket	M99

*Only available with ED5600L and 5600(A)L
[^]9903/9905 trims only.

Electrified Accessories

Description	Part Number
Controller (Required for Electric Latch Pullback(M94))	782
Power supply 1.0 Amp @ 12 VDC output	BPS-12-1
Power supply 3.0 Amp @ 12 VDC output	BPS-12-3
Power Supply 1 Amp @ 24 VDC Output	BPS-24-1
Power Supply 2 Amp @ 24 VDC Output	BPS-24-2
Power Supply 4 Amp @ 24 VDC Output	BPS-24-4
SPDT Maintained Switch	MKA
SPDT Momentary Switch	MK
SPDT Momentary NS Switch	MKN
DPDT Momentary Switch	MK2
DPST Maintained (Al. Action) Switch	PB3EA
Sonalert 90lbs. @ 2 ft. 12-24VDC mounted on one gang stainless steel plate	PZ1
Alarm Kit (cylinder is not included)*	ED50AK
Concealed transfer for over 120° swing doors	EPTL

How to Order

ED5000

Ordering Examples

Exit Device Only*

Quantity	Series/ Function	Finish	Hand	Misc. Options
65	ED5200S	626	RHR	M51

*To order mortise exit device only, see Mortise Exit Only below.

Trim Only

Quantity	Trim/ Function	Finish	Hand	Door Thickness
24	N955	625	RHR	D214

Where to find ordering information and Quick Codes

Functions and Trims
Rim and
Vertical Rod..... Pg 20
Mortise Pg 30
Cylinders and Keying.. Pg 55
Door Height..... Pg 55
Door Width..... Pg 55

Strike Pg 55
Finish Pg 56
Door Thickness..... Pg 56
Handing..... Pg 56
Miscellaneous
Options..... Pg 56
Removable Mullion Pg 57

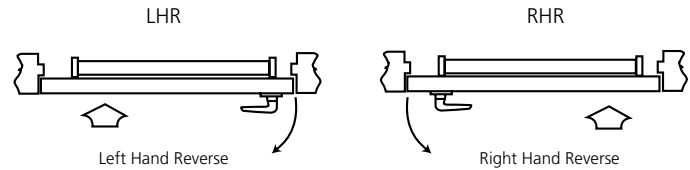

Note: Arrow () indicates secure side of door.

Exit Device with Trim

Quantity	Exit Device	Trim/ Function	Finish	Hand	Door Thickness	Optional Strike	Door Width	Misc. Options
65	ED5600L	N9M55	605	LHR	D214	SB214	W048	M51-M54

Contract/Detailed Order – Surface Vertical Rod Exit Device with Trim

Quantity	Keyset	Exit Device	Trim/ Function	Finish	Hand	Door Height	Door Width	Misc. Options	Cylinder Option
36	AA1	ED5470	C955	626	LHR	H1000	W048	M52-M54	7P

Mortise Exit Only

Trim Type	Functions	Panic	Fire
Knob	Passage	ED5600K	ED5600AK
	Classroom		
	Nightlatch	ED5657K	ED5657AK
	Dummy		
Lever or Flat Plate	Passage	ED5600L	ED5600AL
	Classroom		
	Double Cylinder (Classroom function lever Trim only)	ED5602L	ED5602AL
	Nightlatch	ED5657L	ED5657AL
Thumbpiece	Dummy	ED5600T	ED5600AT
	Passage		
	Classroom	ED5657T	ED5657AT
	Nightlatch		
Dummy			

Removable Mullion

Quantity	Mullion	Misc. Options
6	908A	M96

How to Order the Muséo® Piet Levers

ED5000

Muséo® Piet Lever Collection Trim and Finish Options



Leather Insert
21L



Santoprene™ Insert
21S



Wood Insert
21W



Plain
25M

Trim	Lever Finish Options					
Lever Style	Shank Finish	Specify	Insert Finish	Specify	Grip Finish*	Specify
21L	629 or 630	29 or 30	Black or Brown	BK or BN	629 or 630	29 or 30
21S	629 or 630	29 or 30	Black	BK	629 or 630	29 or 30
21W	629 or 630	29 or 30	Birch	BH	629 or 630	29 or 30
25M	629 or 630	29 or 30	N/A	00	629 or 630	29 or 30



Polished with Satin
Insert
21M



With Raised Band
23M

Trim	Lever Finish Options					
Lever Style	Shank Finish	Specify	Insert Finish	Specify	Grip Finish	Specify
21M	629	29	630	30	629	29
23M	629	29	N/A	00	630	30

*Grip finish must match shank finish

How to Order the Muséo® Piet Levers

ED5000

How to Order the Muséo® Piet Lever Collection

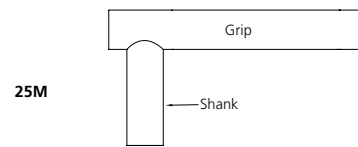
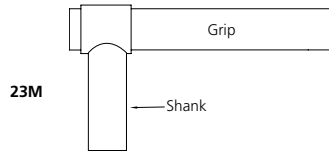
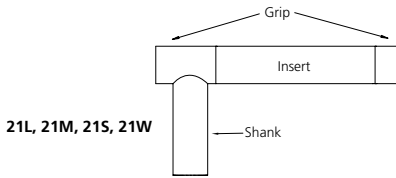

Trim Only

Quantity	Trim/Function	Lever Finish	Lock Finish	Hand
2	21M910	293029	629	RHR

Exit Device with Trim

Quantity	Exit Device	Trim/Function	Lever Finish	Lock Finish	Hand	Cylinder Option	Door Thickness	Optional Strike	Door Width
2	ED5600LN	21W9M10	29BH29	629	LHR	6P	D200	SB214	W048

Abrasive Coat

Hard granular material applied to provide a non-slip tactile surface for the visually impaired.

Active Door

In a pair of doors, the door that is operable from the trim side.

Astragal

A vertical member applied to one or both sides of a pair of doors at the meeting edges. The astragal closes the gap between the two doors.

Coordinator

A device used on a pair of doors to ensure that the inactive door closes before the active door.

Deadlocking Latch

A supplemental latch that automatically deadlocks the latchbolt when pressure is applied to it.

Dogging

A mechanism that allows the latchbolt to remain retracted, permitting the door to operate as if it were a push-pull; it cannot be used on fire-rated exit devices.

Double Egress

A pair of doors of the same hand that swing in opposite directions, commonly found in corridors.

Dummy Trim

Trim only. Usually used on the inactive door of a pair of doors for design balance.

Exit Device (Panic Hardware)

A door locking device with a pushpad or crossbar which, when pressed, allows instant exit (egress).

Fire Exit Hardware

An exit device listed by an independent testing laboratory as meeting panic, fire and hose stream test standards; used on fire-rated openings.

Hand

The direction a door swings.

Inactive Door

In a pair of doors, the door that is inoperable from the trim side.

Latchbolt

A lock component that has a beveled end and projects into a strike, holding the door in a closed position.

Mullion

A fixed or removable vertical member that divides a door opening and provides a latch surface for a pair of rim exit devices.

Open Back Strike

For mortise exit devices, used on the inactive door (usually the vertical rod door) of a pair of doors that swing in the same direction. It permits the inactive door to open or close independently.

Reversible

Pertains to a product that may be changed in the field to accommodate any hand of the door.

Shim Kit

Pieces of metal that permit mounting of an exit device on a door that has a surface projecting vision light (glass bead) molding.

Split Astragal

An astragal that is split through the middle on a pair of doors, allowing both doors to operate independently.

Threshold

A strip fastened to the floor beneath a door. It serves as a stop, prevents heat loss, and provides a strike location for latching the bottom rod of a vertical rod exit device.

Trim

A knob, lever, pull, or thumbpiece used on the outside of an exit device door to control access to an area.

Universal Exit Device

An exit device that may be used on doors of either hand without any modifications.

Keying and Cylinder Terms

Blockout Cylinder

A cylinder which allows all keys to be temporarily blocked from operating. It is set by a blockout key.

Concealed Key Control (CKC)

The marking of standard key symbols on a cylinder in a location that is not visible once the cylinder is installed.

Construction Master Keying (CMK)

A cylinder preparation that allows temporary access by construction personnel.

Control Key

A key used to remove and install interchangeable cores.

Cylinder

A lock component containing the combination that determines which keys will operate.

Security Cylinder

A cylinder which provides extra resistance to picking and unauthorized duplication of keys.

Interchangeable Core (IC)

A cylinder which can be removed and installed quickly with a control key by non-skilled personnel when rekeying is required.

Key Symbol

A letter/number combination in standard industry format (e.g., 1AA, AA1, etc.) which indicates exactly how a key or cylinder fits into a keying system.

Keyway

The opening in a cylinder plug through which the key enters.

Master Keying

Preparation of a cylinder to operate with keys of different levels of access.

Visual Key Control (VKC)

The marking of standard key symbols on keys and on the visible portion of the front of a cylinder.

How to Specify

ED5000

Suggested Specification for Panic and Fire-Rated Exit Devices

Exit devices shall be ED5000 Series Pushpad Exit Devices as manufactured by Corbin Russwin Architectural Hardware.

The exit device chassis shall be cold forged steel, electroplated for corrosion resistance, and shall be architecturally finished brass, bronze or stainless steel. The pushpad mechanism shall be constructed of extruded aluminum and shall be scalped with architecturally finished brass, bronze or stainless steel. The maximum projection shall be 3-1/4" when the pushpad is active and 2-3/4" when the pushpad is dogged down. Nylon bearings and stainless steel springs shall be used for long life and durability; only torsion springs are acceptable. Rear and active case covers shall be wrought brass or bronze and shall be plated to match the exit bar. Plastic or painted covers are not acceptable. Latchbolts shall be steel and shall incorporate a deadlocking latch for increased security. Devices without deadlocking latches are not acceptable. Mounting screws shall be concealed to deter tampering. Devices shall be closed on all sides with no pinch points. All exit devices shall be easily field sized to accommodate various door widths.

Panic-listed exit devices shall have single-point, one quarter turn hex key dogging standard. Optional cylinder dogging shall be available on panic listed devices only. Devices with hex key dogging shall be easily field converted to cylinder dogging. Panic-listed devices shall be available less dogging.

Trims shall be through-bolted with concealed fasteners. Escutcheon and pull type trims shall be constructed of brass or bronze. All lever trims shall use cast or forged levers. On trims with cylinders, the mechanism that locks and unlocks the trim shall be housed in the trim and not in the active case of the exit device. Rim and vertical rod lever trims shall be Free Wheeling with clutch mechanism allowing lever to rotate 60° when locked to prevent vandalism. Lever trims shall match those on Corbin Russwin Mortise and Cylindrical Locksets.

Exit devices and trims shall be furnished in BHMA standard architectural finishes.

Exit devices shall be listed by Underwriters Laboratories (UL) for safety as panic hardware. Fire-rated devices shall be listed for A label and lesser class doors.

Certification:
ANSI A156.3, Grade 1

Devices, trims and cylinders shall be from one manufacturer.

Devices and 900 series trim shall carry a five-year limited warranty.

Electronic components shall carry a two-year limited warranty.

Suggested Specification for Delayed Egress Exit Devices

Delayed egress exit devices shall be ED4000/ED5000 series (rim, SecureBolt®, mortise or concealed vertical rod) with the "D" suffix, manufactured by Corbin Russwin Architectural Hardware.

The delayed egress exit device secures the door in the locked mode. Depressing the pushpad for less than three seconds will sound the device nuisance beep without initiating the alarm. Depressing the pushpad longer than three seconds will initiate an irreversible local audible beeping tone and allow the device to release for egress after 15 seconds (or 30 seconds may be accepted by local jurisdiction) and sound the alarm. The alarm will continue until reset by the mechanical key switch located on the device.

Devices shall be 24 volts DC.

The exit device chassis shall be cold forged steel, electroplated for corrosion resistance, and shall be architecturally finished brass, bronze or stainless steel. The pushpad mechanism shall be constructed of extruded aluminum and shall be scalped with architecturally finished brass, bronze or stainless steel. The maximum projection shall be 3-1/4" when the push pad is active and 2-3/4" when the push pad is depressed. Nylon bearings and steel springs shall be used for long life and durability. Active case and alarm end cover shall be wrought brass, bronze or stainless steel and shall be plated to match the exit bar. Painted or plastic covers or end caps are not acceptable. Latch bolts shall be steel and shall incorporate a deadlocking latch for increased security. Devices without deadlocking latches are not acceptable. Mounting screws shall be concealed to deter tampering. Devices shall be closed on all sides with no pinch points. Device active cover and end cap attaching screws shall be security Torx® pin.

Trims shall be through-bolted with concealed fasteners. Escutcheon and pull-type trims shall be constructed of brass, bronze or stainless steel. All lever trims shall use cast or forged levers. On trims with cylinders, the mechanism that locks and unlocks the trim shall be housed in the trim and not in the active head of the Exit Device. Rim and vertical rod lever trims shall be Free Wheeling with clutch mechanism allowing lever to rotate 60° when locked to prevent vandalism. Lever trims shall match those on Corbin Russwin mortise and cylindrical locksets.

Devices shall be listed by UL/cUL as Controlled Exit Panic Devices or Special Locking Arrangement and meet all requirements for NFPA 101.

Certification:

ANSI 156.3, Grade 1/ANSI 156.24

UL/cUL FUKD/FUKD7 - Controlled Panic Device

UL/cUL FWAX/FWAX7 - Special Locking Arrangements

Exit devices, trims and cylinders must be from one manufacturer.

Exit devices and heavy-duty trims shall have a five-year warranty. Electronics shall have a two-year warranty.



ASSA ABLOY

In U.S.

Corbin Russwin
Architectural Hardware
225 Episcopal Road
Berlin, CT 06037
Phone: 800-543-3658
Fax: 800-447-6714
corbinrusswin.com

In Canada

ASSA ABLOY Door
Security Solutions Canada
160 Four Valley Drive
Vaughan, Ontario
Canada L4K 4T9
Phone: 800-461-3007
Fax: 905-738-2478
www.assaabloy.ca

For more information regarding Corbin Russwin Locksets, Exit Devices, Door Controls and Key Systems, contact your authorized Corbin Russwin Distributor or Sales Representative.



ElectroLynx®

As part of their promise to provide innovative, fast and effective high security solutions to their customers, certain ASSA ABLOY Group brands offer ElectroLynx®, a universal quick-connect system that simplifies the electrification of the door opening.

ElectroLynx® is a registered trademark of ASSA ABLOY Inc.



MicroShield®

As part of their promise to provide innovative solutions to their customers, certain ASSA ABLOY Group brands offer the MicroShield® technology, a silver-based antimicrobial coating designed to inhibit the growth of bacteria. MicroShield® is a registered trademark of Yale Security Inc., an ASSA ABLOY Group company.

Corbin Russwin and Design®, SecureBolt® and Muséo® are registered trademarks of Corbin Russwin, Inc., an ASSA ABLOY Group company. PathLite™ and Vineyard™ are trademarks of Corbin Russwin, Inc., an ASSA ABLOY Group company. Other products' brand names may be trademarks or registered trademarks of their respective owners and are mentioned for reference purposes only. These materials are protected under US copyright laws. All contents current at time of publication. Corbin Russwin, Inc., an ASSA ABLOY Group company reserves the right to change availability of any item in this catalog, its design, construction, and/or its materials. Copyright © 2000, 2014 Corbin Russwin, Inc., an ASSA ABLOY Group company. All rights reserved. Reproduction in whole or in part without the express written permission of Corbin Russwin, Inc. is prohibited.

ASSA ABLOY is the global leader in door opening solutions, dedicated to satisfying end-user needs for security, safety and convenience.