

REVISIONS				
ZONE	REV	FINISHES:	DATE	APPROVED
		PB, AB, BZ, 10B & S		

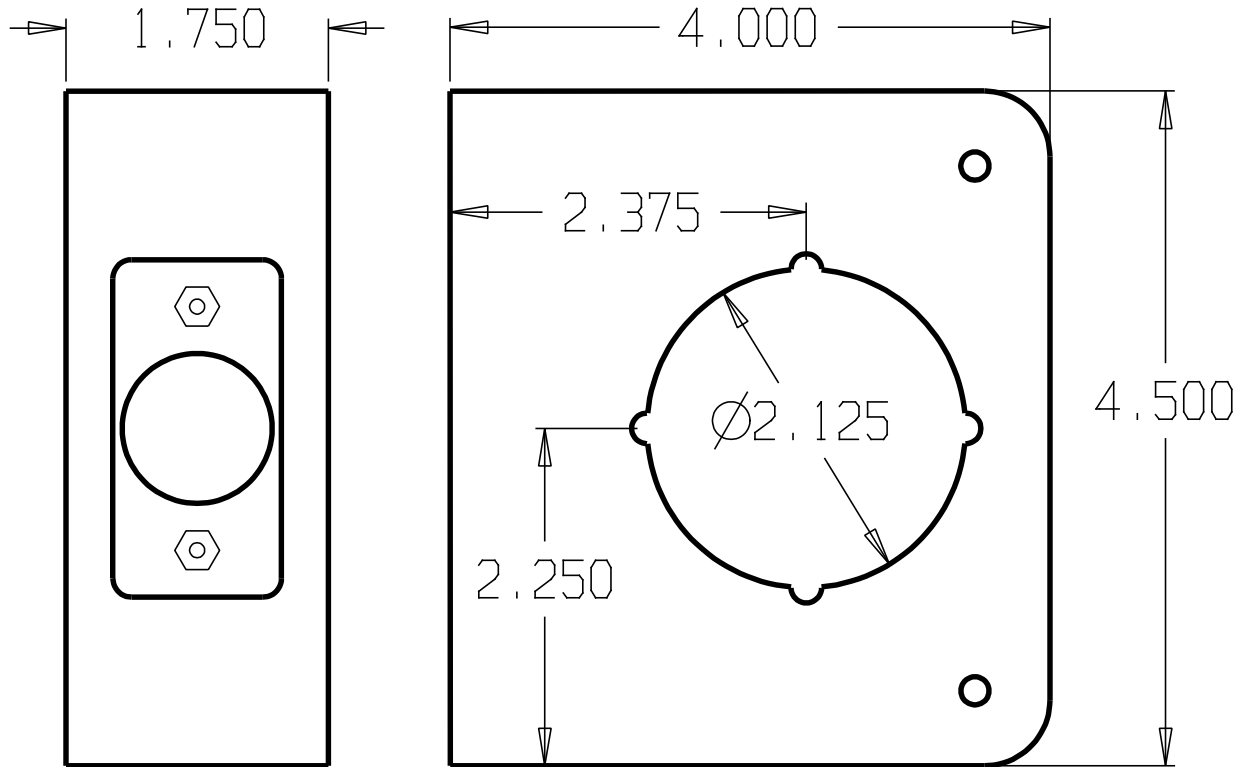

DON-JO MFG. INC.

DESIGNER	
APPROVED	

SIZE	DATE:	PART NO.	REV
A	4/28/04	61-CW	
SCALE	RELEASE DATE	WEIGHT	SHEET